



tear away
Quilting
elementz.

Quilting Designs for Domestic Machine Quilters

Tear Away Catalog

Fall 2024

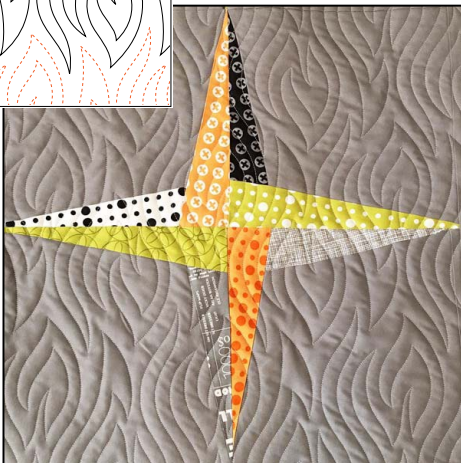
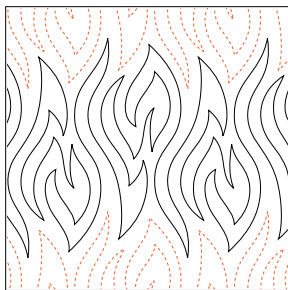
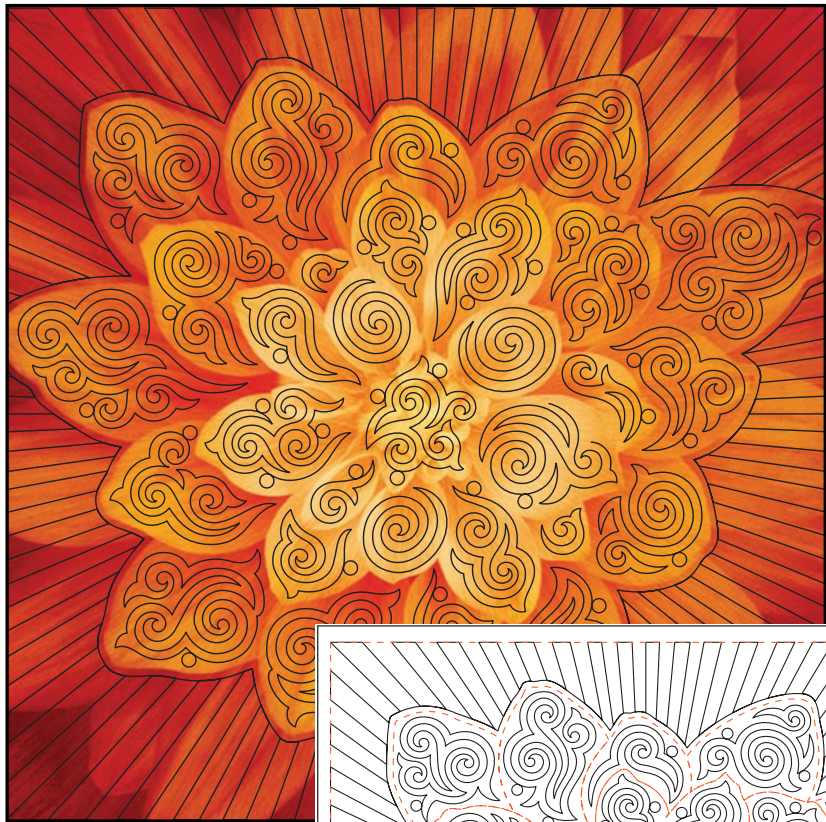

Kindling
Tear Away

© Patricia E. Ritter
& Leisha Farnsworth

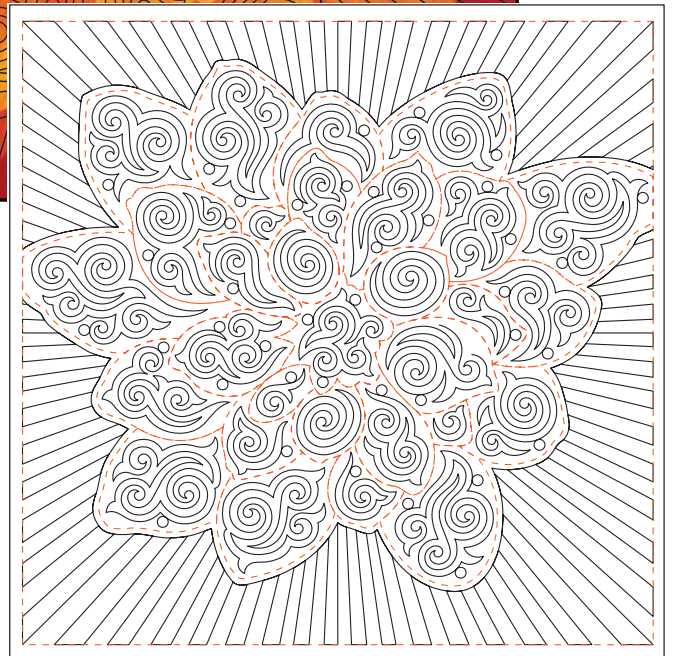

Dream Big with Aquarius
Tear Away

© Patricia E. Ritter



Just Place, Quilt and TEAR AWAY!

*Created especially for every quilter ...
Pre-printed quilting paper compatible with any domestic or longarm quilting machine and frame.*

Place our Tear Away designs onto your quilt with basting adhesive,
quilt directly on top of the design,
tear away when done!

The sizing listed is the height of a single row. Allover designs are 48" in length.
Allover design packs include **four** tear away sheets.
Corner design packs include **four** individual corners.
Block design packs include **twelve** individual blocks.
Dream Big design packs include **three** tear away sheets.

Additional information and pricing can be found at:
www.urbanelementz.com

PATENT PENDING



Wholesale Ordering Information:

1. To qualify to purchase wholesale, you must have:

- a. A valid resale/tax ID number
- b. A completed wholesale application
- c. Plus TWO of the following
 - a physical or web-based business
 - a listing in your local city yellow page directory
 - invoice showing wholesale purchase(s) from another company
 - a business address different from your home address
 - a business phone different from your home phone

2. Wholesale minimums for orders are as follows:

Appliques:	min. 3 per item, 12 designs total
Patterns:	min. 6 per item, 12 patterns total
Pantographs:	min. 3 per item, 18 pantographs total
Stencils:	min. 3 per item, 18 stencils total
Tattoos:	min. 3 per item, 18 tattoos total
Tear Away:	min. 3 per item, 18 designs total
Miracle Chalk:	min. 3 per item, 12 miracle chalk products total

NOTE: Downloadable products are only available at retail pricing.

For more information about ordering visit:

www.urbanelementz.com
www.appliqueelementz.com

Dream Big with Urban Elementz

Fits Hoffman Dream Big Panel or can be used as a wholecloth on fabric of your choice.

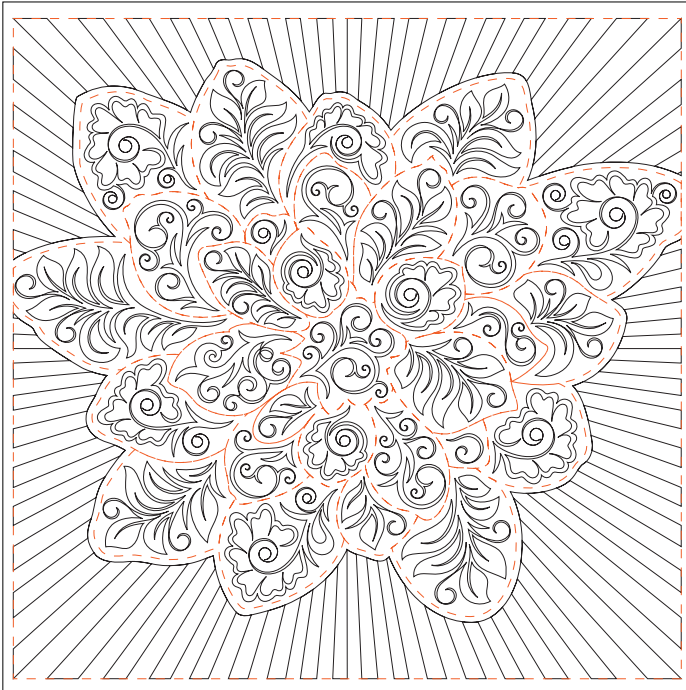

Dream Big in Technicolor #1
43.5" x 43"

© Patricia E. Ritter, Melonie J. Caldwell & Leisha Farnsworth

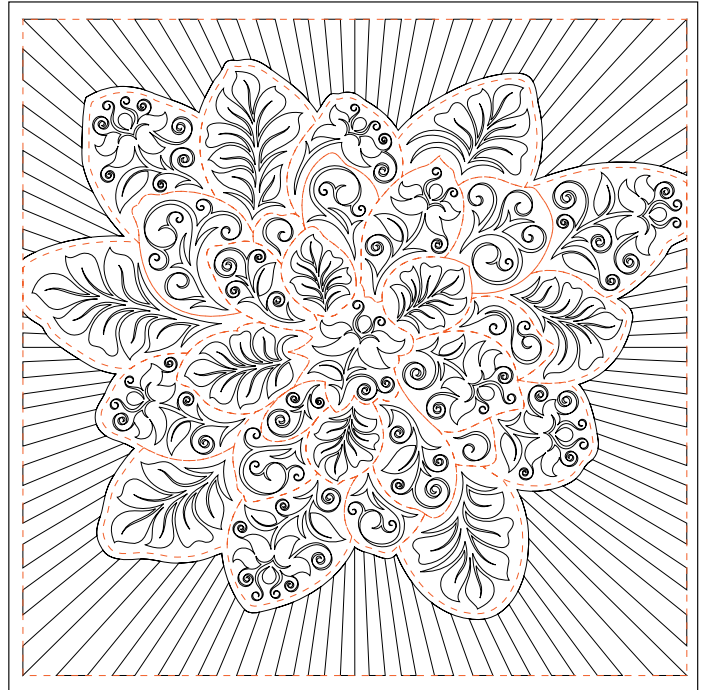

Dream Big in Technicolor #2
43.5" x 43"

© Patricia E. Ritter, Melonie J. Caldwell & OESD

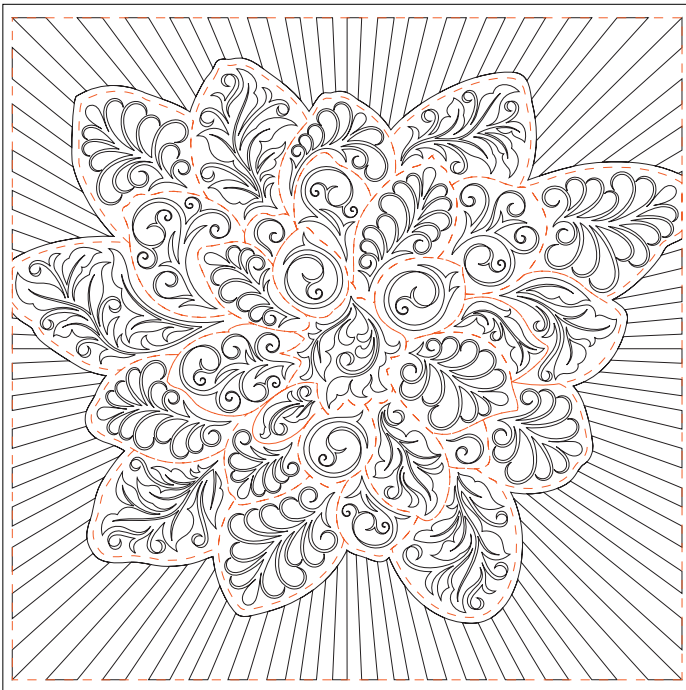

Dream Big in Technicolor #3
43.5" x 43"

© Patricia E. Ritter, Melonie J. Caldwell, Tracey Russell & Jessica Schick

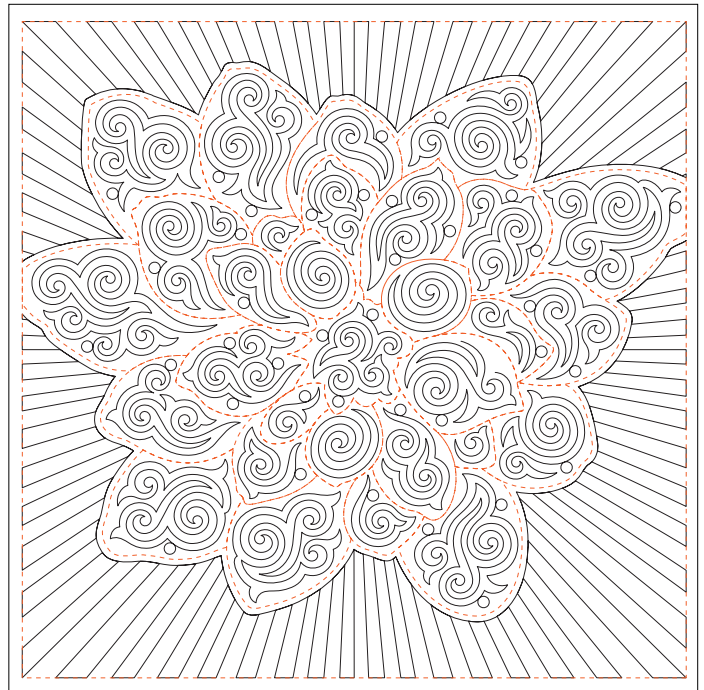

Dream Big with Aquarius
43.5" x 43"

© Patricia E. Ritter

Dream Big with Urban Elementz

Fits Hoffman Dream Big Panel or can be used as a wholecloth on fabric of your choice.

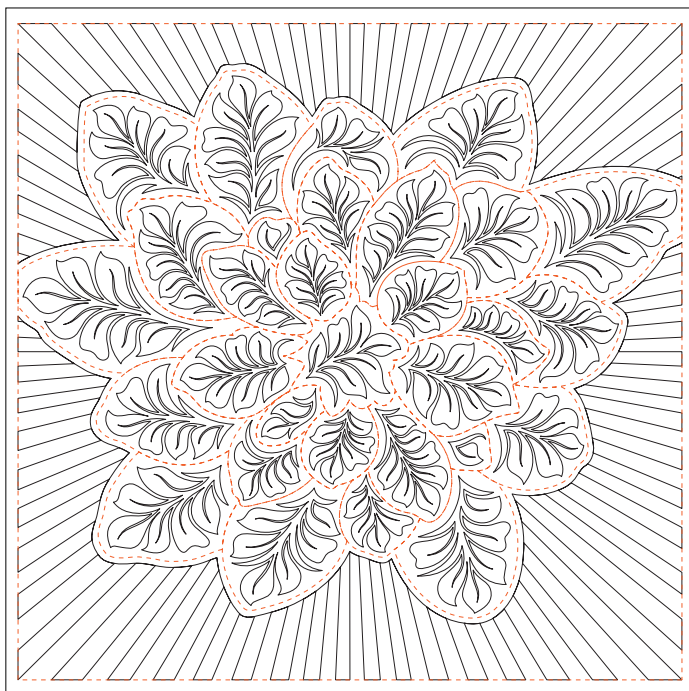

Dream Big with Avalon
43.5" x 43"

© Patricia E. Ritter & OESD

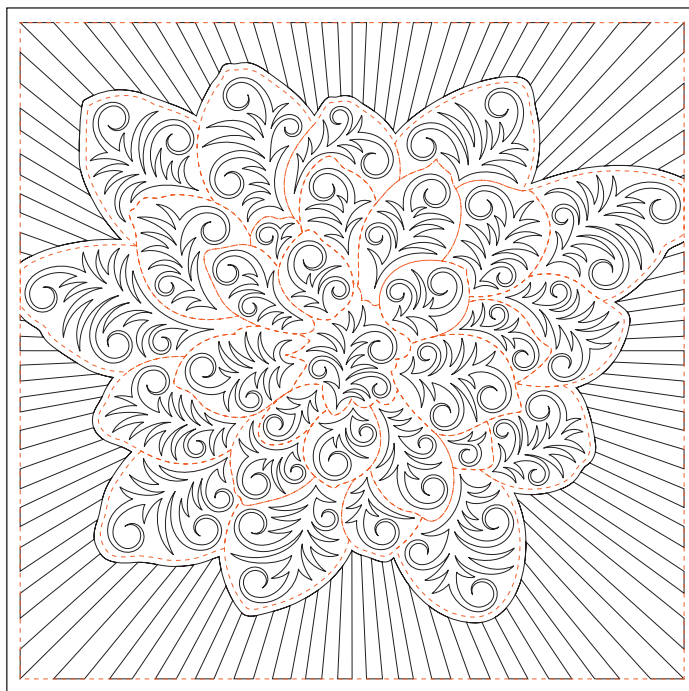

Dream Big with Baltic
43.5" x 43"

© Patricia E. Ritter & Tracey Russell

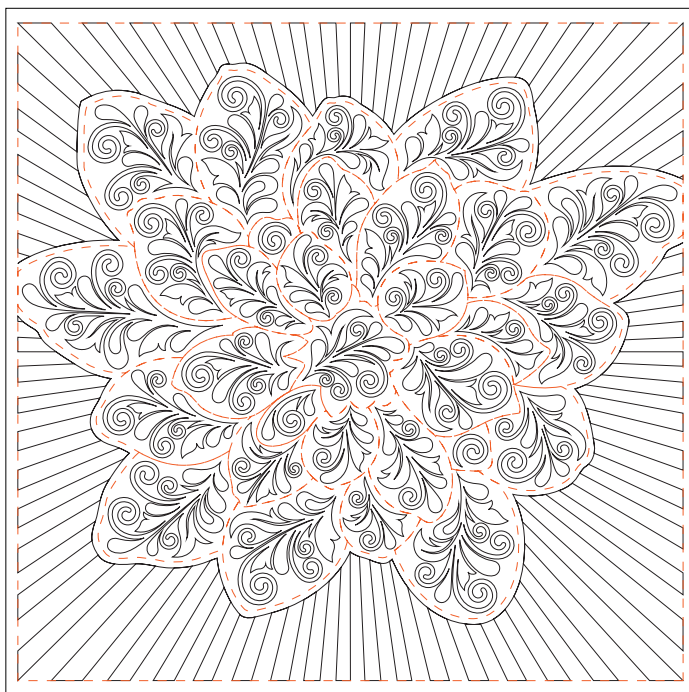

Dream Big with Blooming Feathers
43.5" x 43"

© Patricia E. Ritter & Bethanne Nemesh

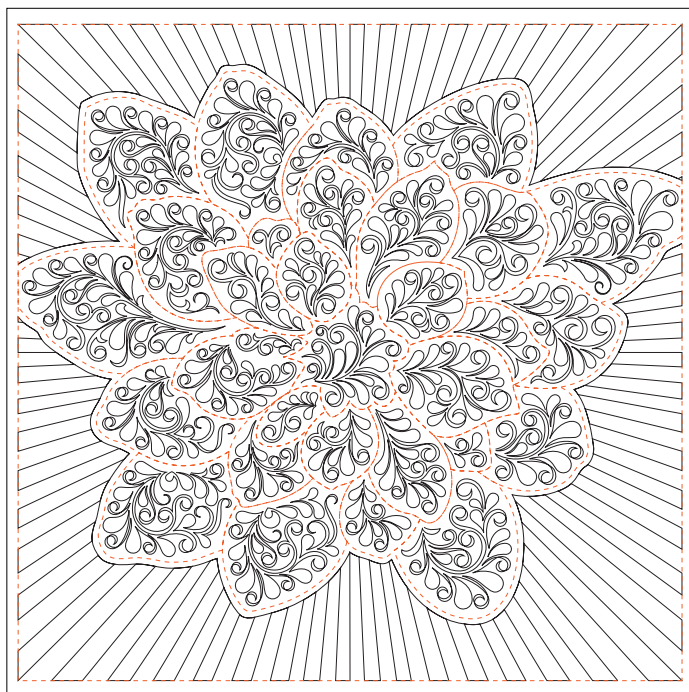

Dream Big with Cardamom
43.5" x 43"

© Jessica Schick

Dream Big with Urban Elementz

Fits Hoffman Dream Big Panel or can be used as a wholecloth on fabric of your choice.

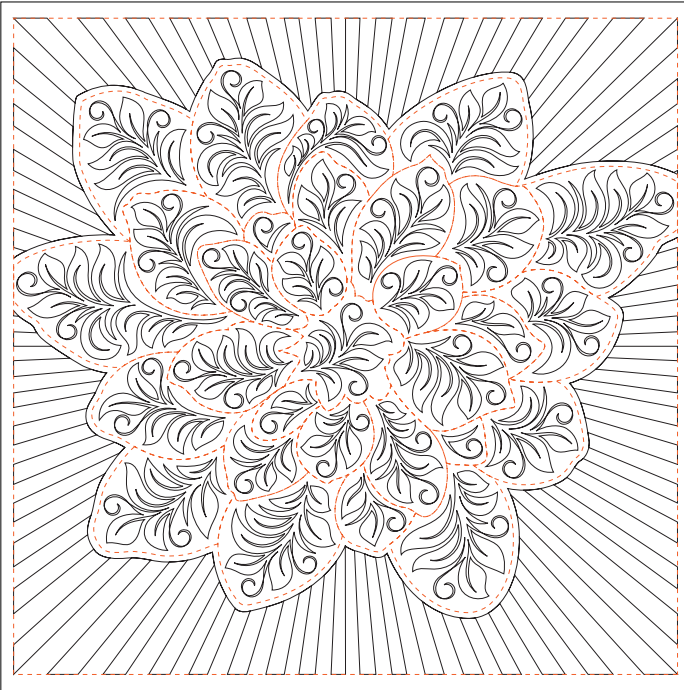

Dream Big with Central Park West
43.5" x 43"

© Patricia E. Ritter

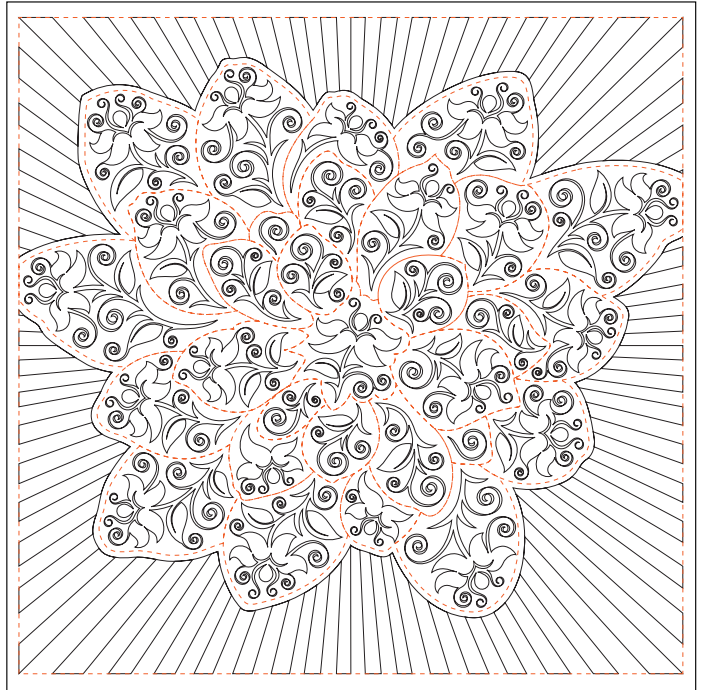

Dream Big with Kimono
43.5" x 43"

© Patricia E. Ritter & OESD

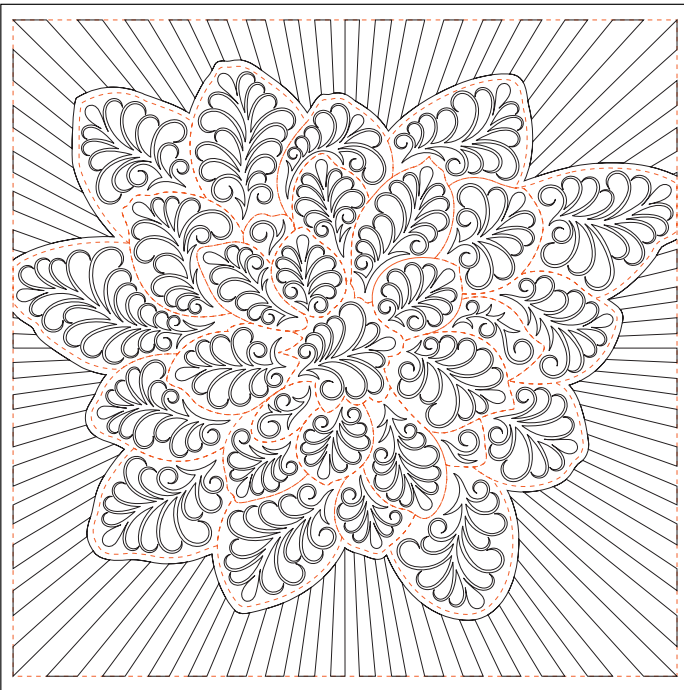

Dream Big with Magenta
43.5" x 43"

© Patricia E. Ritter & Tracey Russell

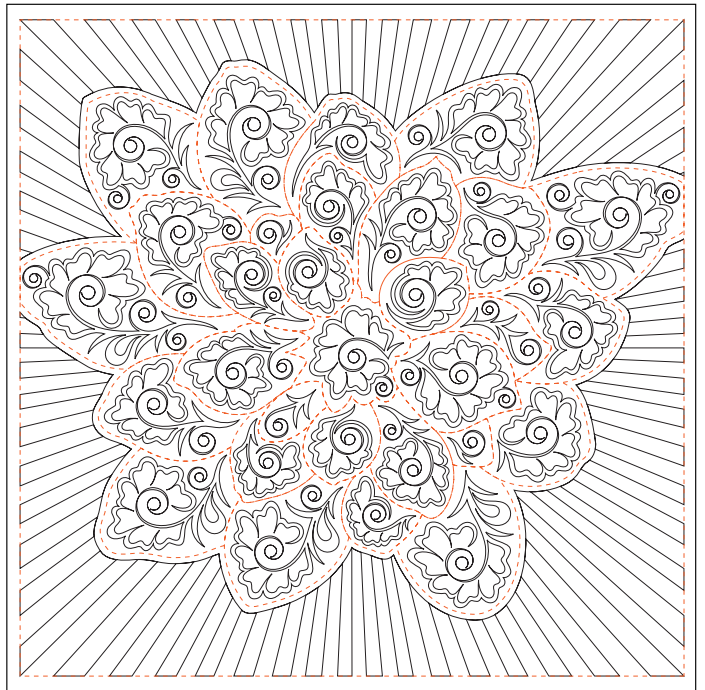

Dream Big with Marigold
43.5" x 43"

© Patricia E. Ritter & Leisha Farnsworth

Dream Big with Urban Elementz

Fits Hoffman Dream Big Panel or can be used as a wholecloth on fabric of your choice.

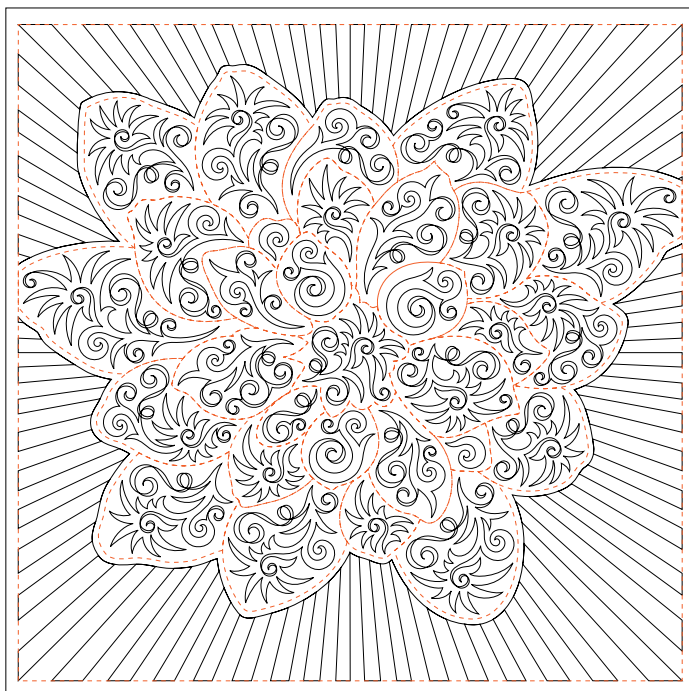

Dream Big with Passion Flower
43.5" x 43"

© Patricia E. Ritter

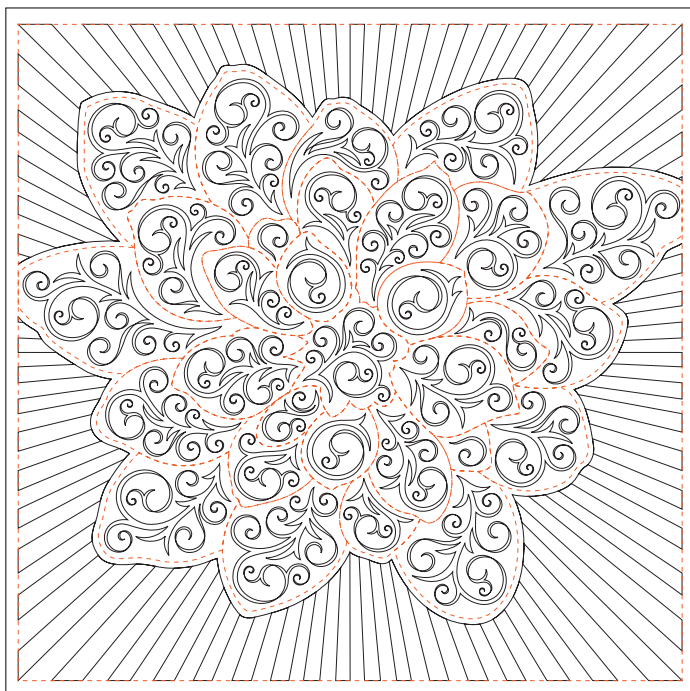

Dream Big with Pizzazz
43.5" x 43"

© Patricia E. Ritter & Melonie J. Caldwell



Dream Big with Rhubarb
43.5" x 43"

© Jessica Schick

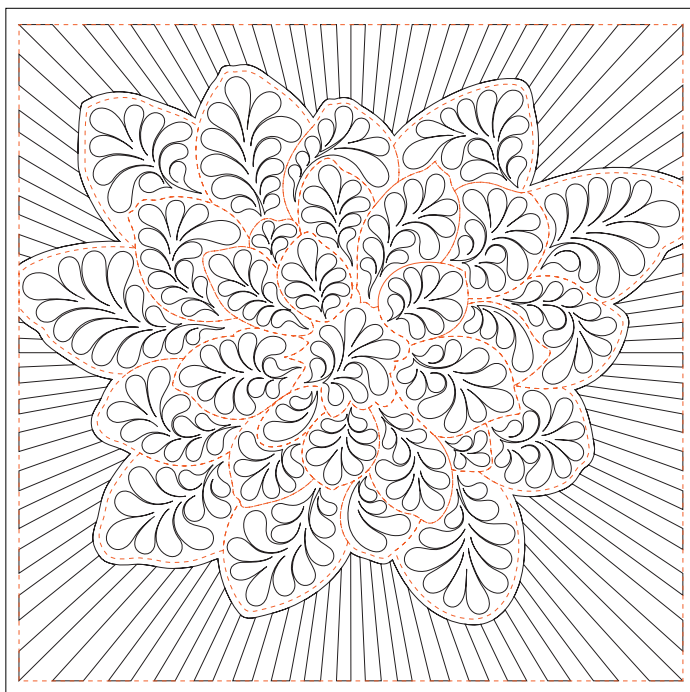

Dream Big with Vivaldi
43.5" x 43"

© Patricia E. Ritter

Edge-to-Edge, Corner & Block Designs

Pre-printed quilting paper compatible with any domestic or longarm quilting machine and frame.

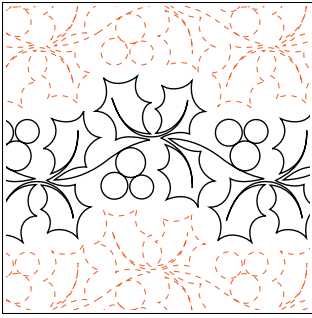

A Merry 'Lil Christmas - Petite
5.75" row
© Patricia E. Ritter

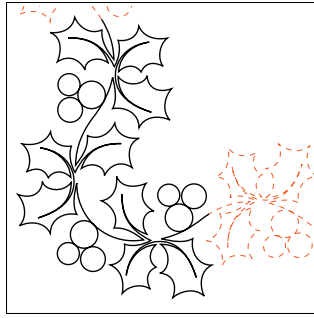

A Merry 'Lil Christmas - Petite - Corner
© Patricia E. Ritter

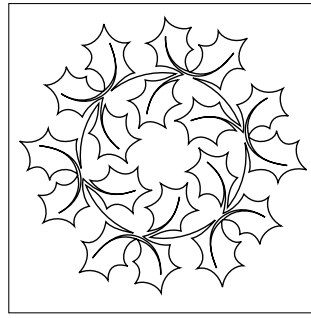

A Merry 'Lil Christmas - Block #2
12.25" x 11.75" block
© Patricia E. Ritter

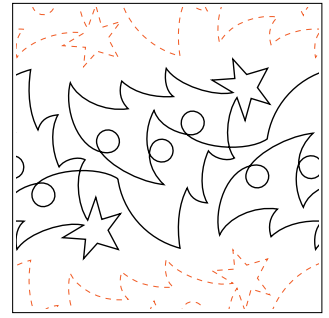

Advent
6.75" row
© Hermione Agee

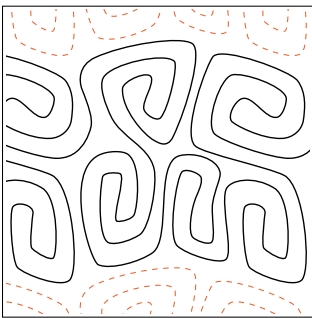

African Samba
7.5" row
© Apricot Moon Designs

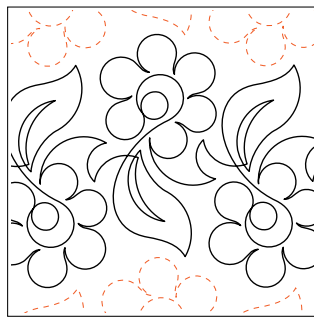

Alfresco
9.25" row
© Hermione Agee

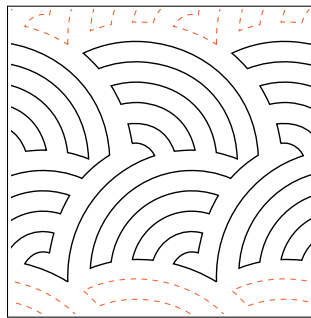

Alternating Baptist Fan
7" row
© Jessica Schick

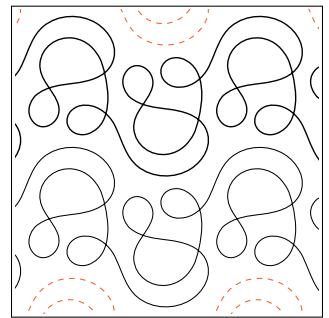

Ampersand
5.5" row
© Patricia E. Ritter & Sarah Ann Myers

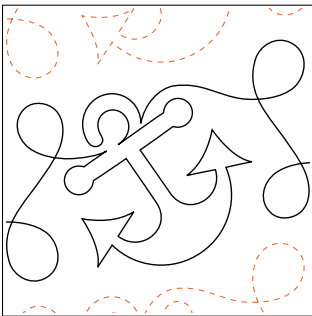

Anchors Aweigh
8.25" row
© Patricia E. Ritter



Animal Crackers
7.5" row
© Patricia E. Ritter

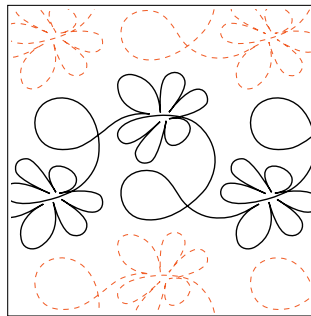

Apricot Moon's Buzz
5.5" row
© Apricot Moon Designs

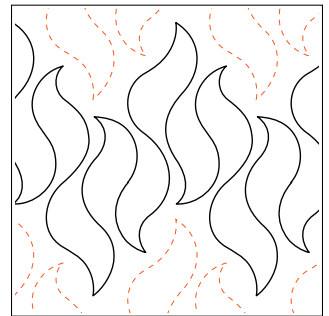

Aqua Flame
9.5" row
© Hermione Agee

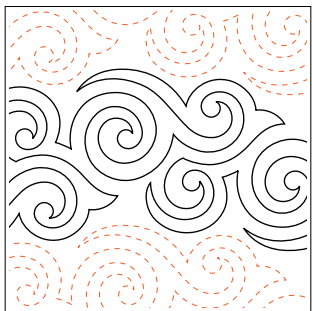

Aquarius - Petite
5" row
© Patricia E. Ritter

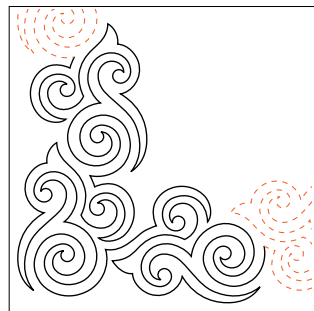

Aquarius - Petite - Corner
© Patricia E. Ritter

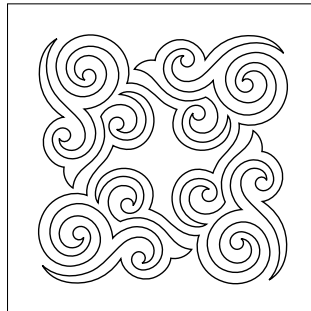

Aquarius - Block #3
11.75" block
© Patricia E. Ritter

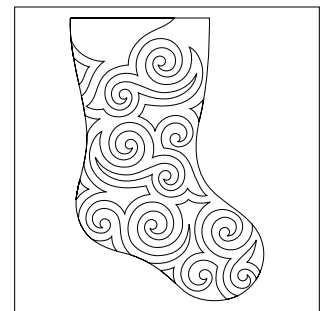

Aquarius - Stocking
12.5" x 18" stocking
© Patricia E. Ritter

Edge-to-Edge, Corner & Block Designs

Pre-printed quilting paper compatible with any domestic or longarm quilting machine and frame.

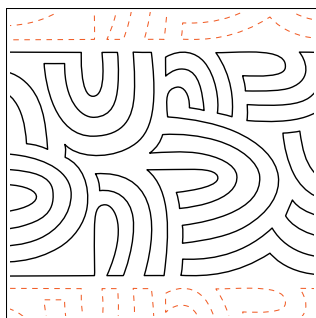

Arches
7.75" row
© Melissa Kelley

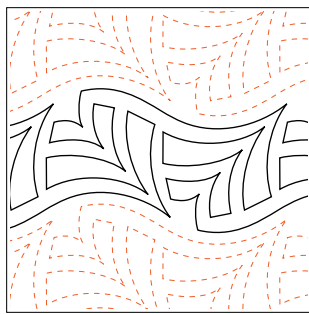

Arrowfull
5.75" row
© Naomi Hynes

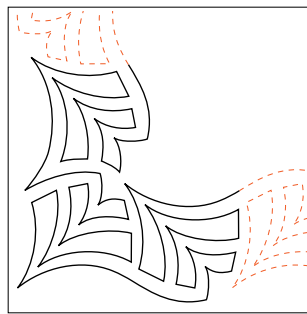

Arrowfull - Corner
© Naomi Hynes

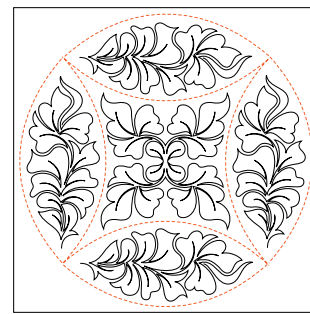

Arugula - DWR - Block
fits 18" circle
© Patricia E. Ritter

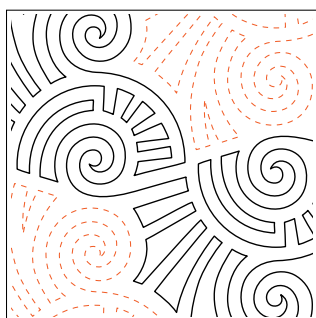

Ba Da Bing
14.75" row
© Patricia E. Ritter



Bailey
6" row
© Melonie J. Caldwell & Jeffery Schillinger

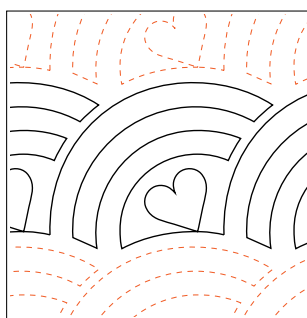

Baptist Heart Fan
5" row
© Kristin Hoftzyer

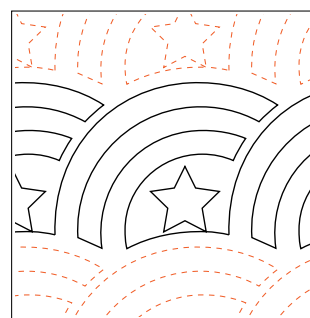

Baptist Star Fan
5" row
© Kristin Hoftzyer

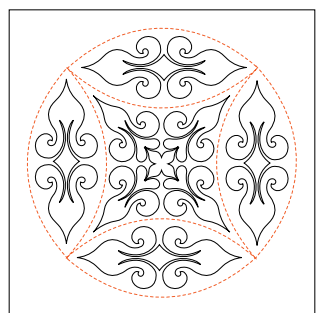

Baroque - DWR - Block
fits 18" circle
© Naomi Hynes

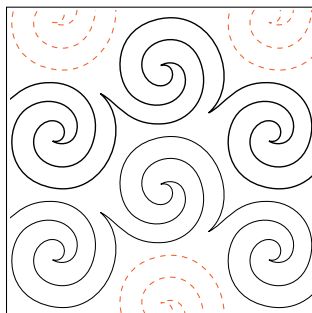

Basic Swirl
6.75" row
© Jamie Wallen / Quilters Apothecary

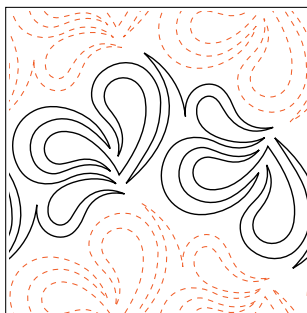

Baton Rouge
6.75" row
© Sarah Ann Myers

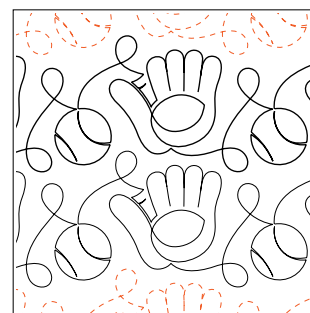

Batter Up - Petite
5.5" row
© Patricia E. Ritter

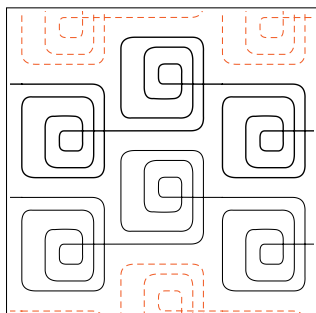

Bauhaus Baby
5.5" row
© Patricia E. Ritter & Denise Schillinger

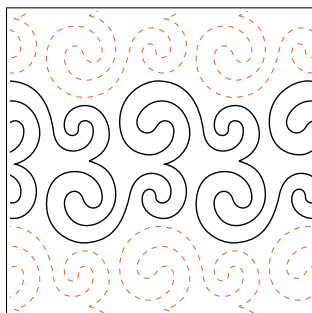

Beaded Curtain
5" row
© Barbara Becker / Four Paws Quilting

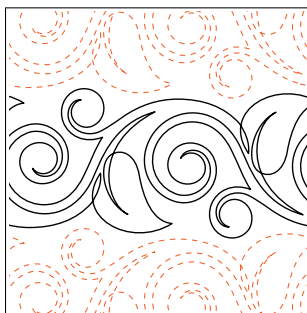

Beaux-Arts
5.25" row
© Patricia E. Ritter & Jamie Wallen / Quilters Apothecary

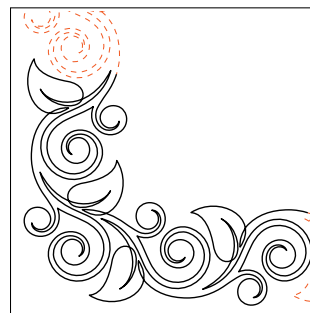

Beaux-Arts - Corner
© Patricia E. Ritter & Jamie Wallen / Quilters Apothecary

Edge-to-Edge, Corner & Block Designs

Pre-printed quilting paper compatible with any domestic or longarm quilting machine and frame.

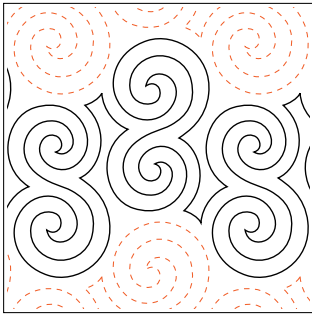

Becker's Crop Circles
8.75" row
© Barbara Becker

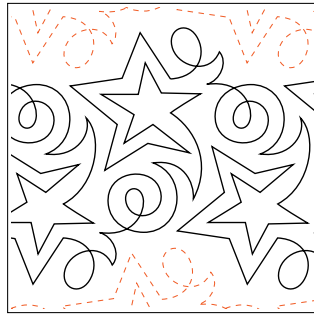

Becker's Shooting Star
9.5" row
© Barbara Becker / Four Paws Quilting

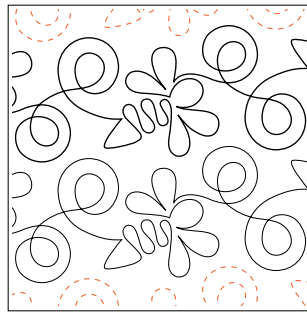

Bee Dazzled
4.25" row
© Patricia E. Ritter

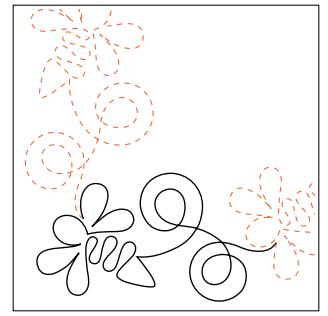

Bee Dazzled - Corner
© Patricia E. Ritter

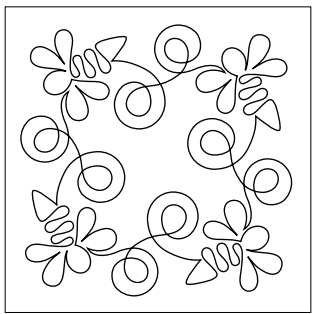

Bee Dazzled - Block
9.5" block
© Patricia E. Ritter

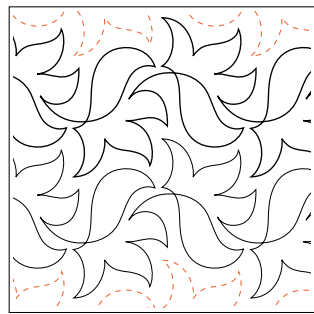

Bellini
5.25" row
© Patricia E. Ritter



Bellini - Corner
© Patricia E. Ritter

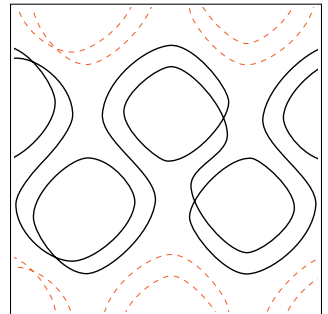

Belly Bop
7" row
© Apricot Moon Designs

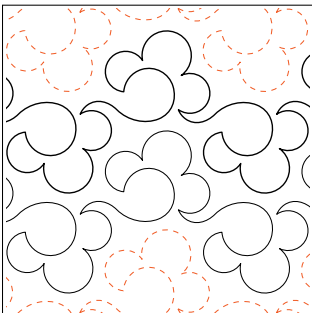

Billowy
5.5" row
© Hermione Agee

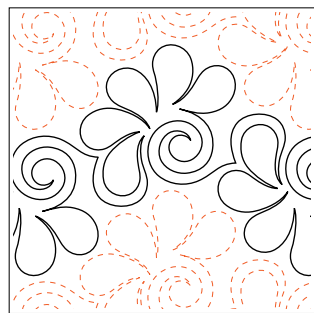

Blissful
6.5" row
© Sarah Ann Myers

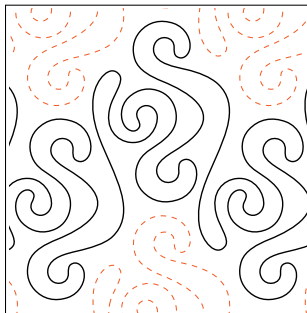

Bolero
9.5" row
© Sarah Ann Myers

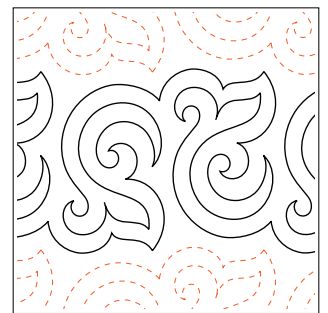

Bourbon Street Baby
5.5" row
© Patricia E. Ritter

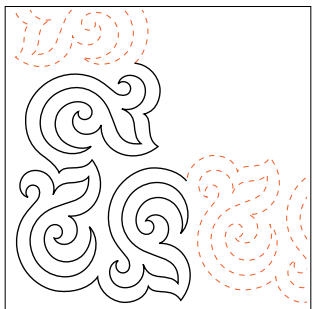

Bourbon Street Baby - Corner
© Patricia E. Ritter

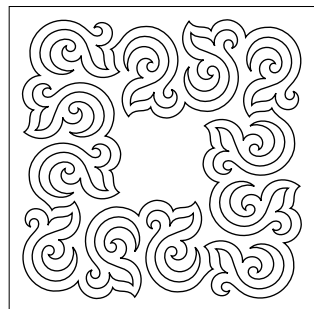

Bourbon Street Baby - Block
15.75" block
© Patricia E. Ritter

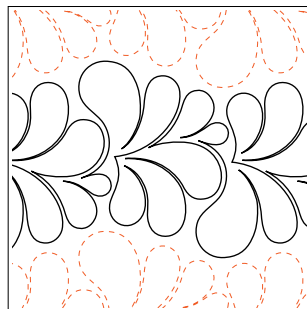

Brioche
5" row
© Patricia E. Ritter

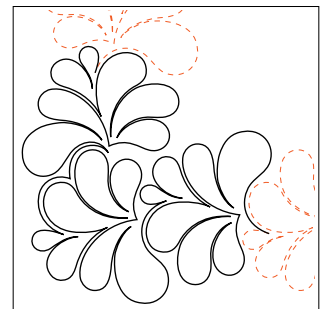

Brioche - Corner
© Patricia E. Ritter

Edge-to-Edge, Corner & Block Designs

Pre-printed quilting paper compatible with any domestic or longarm quilting machine and frame.

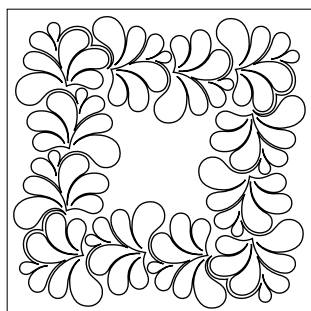

Brioche - Block
13.5" block
© Patricia E. Ritter

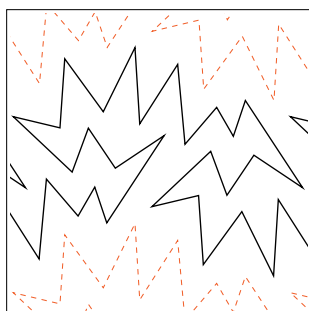

Brittle
6.5" row
© Hermione Agee

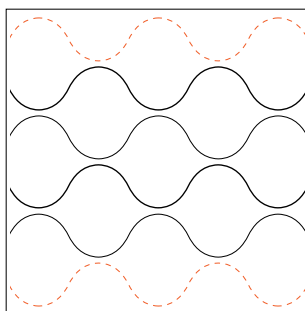

Bubble Wrap - Double Take
1.75" row
© Patricia E. Ritter & Leisha Farnsworth

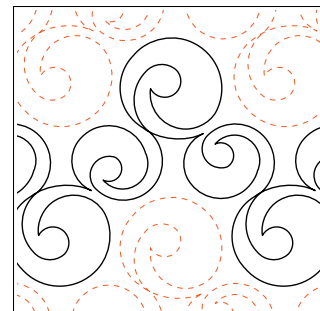

Bubbles
7.25" row
© Hermione Agee

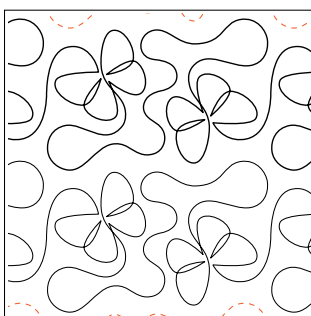

Butterfly Waltz
6.25" row
© Apricot Moon Designs

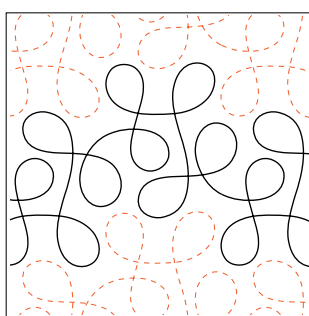

Cakewalk
6" row
© Sarah Ann Myers

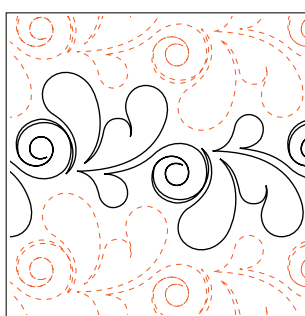

Canary
6.25" row
© Patricia E. Ritter & Leisha Farnsworth

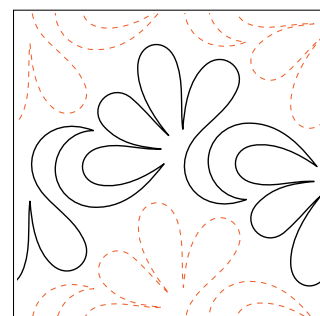

Cassava
7.5" row
© Sarah Ann Myers

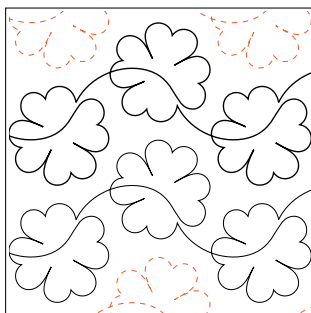

Charmed - Again
6.5" row
© Melonie J. Caldwell

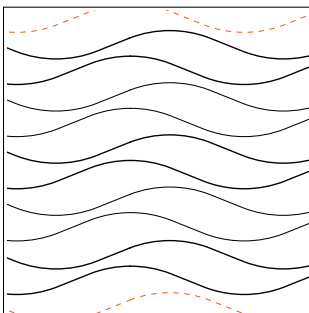

Cindy's Water
.75" row
© It's A Quilt Thing

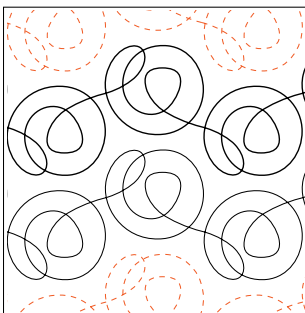

Cinnamon
4" row
© Melonie J. Caldwell

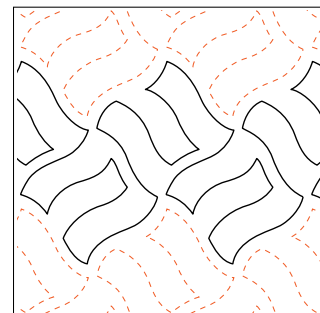

Classic Weave
6.5" row
© Kathie James

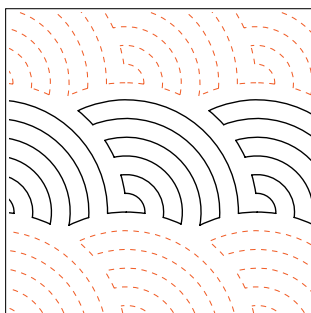

Continuous Baptist Fans
5" row
© Hermione Agee

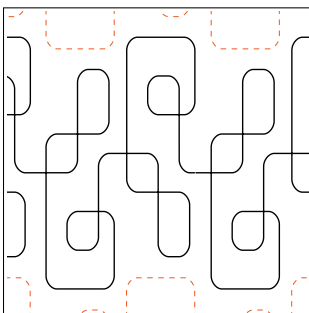

Cool Beans
8.5" row
© Apricot Moon Designs

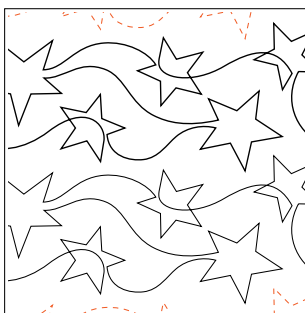

Cosmic
6" row
© Jessica Schick

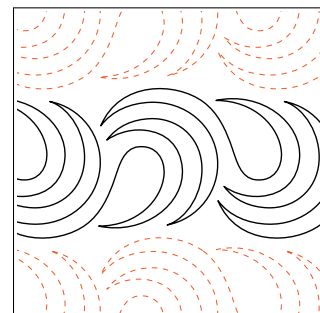

Cove
5" row
© Patricia E. Ritter & Jamie Wallen / Quilters Apothecary

Edge-to-Edge, Corner & Block Designs

Pre-printed quilting paper compatible with any domestic or longarm quilting machine and frame.

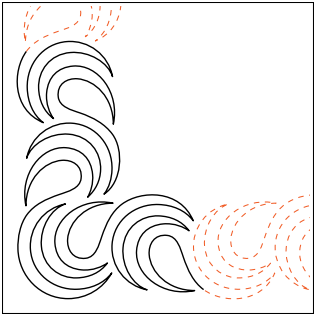

Cove - Corner

© Patricia E. Ritter & Jamie Wallen / Quilters Apothecary

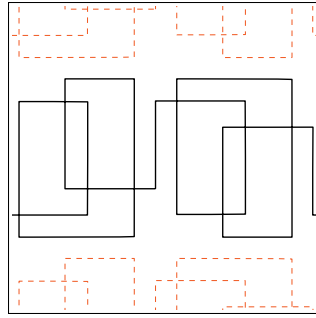

Crochet
4.5" row

© Patricia E. Ritter

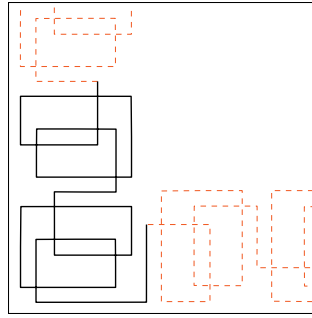

Crochet - Corner

© Patricia E. Ritter

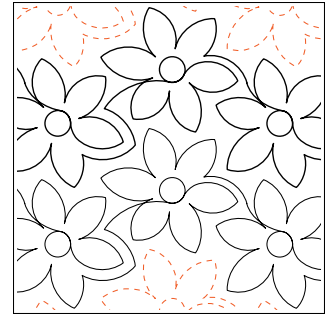

Daisy Delight
7" row

© Hermione Agee

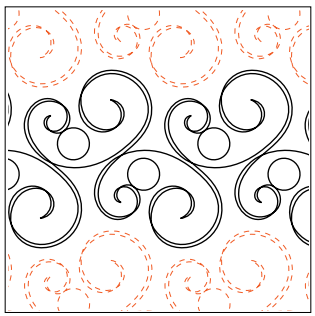

Daisy Doodle - Border
6.5" row

© Patricia E. Ritter

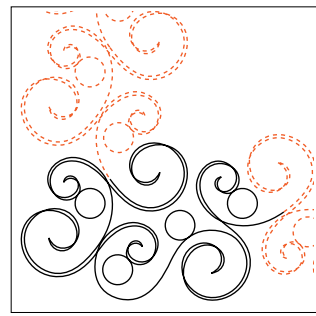

Daisy Doodle - Border - Corner

© Patricia E. Ritter

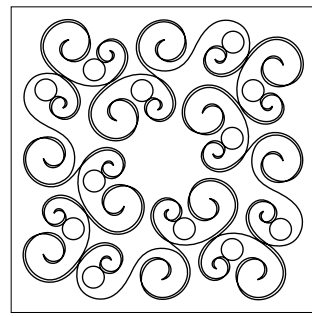

Daisy Doodle - Block #4
13.5" block

© Patricia E. Ritter

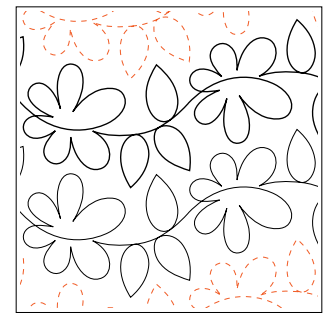

Daisy Dotz #2
6" row

© Patricia E. Ritter

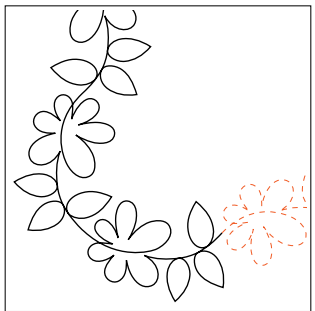

Daisy Dotz #2 - Corner

© Patricia E. Ritter

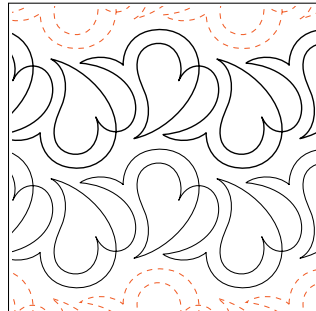

Devotion
4" row

© Hermione Agee

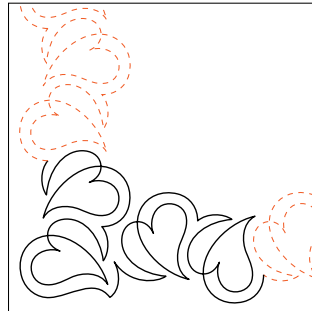

Devotion - Corner

© Hermione Agee

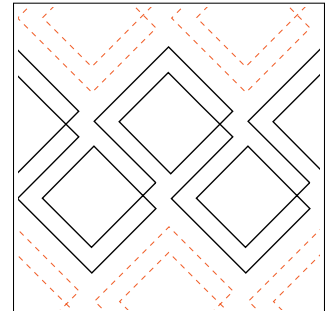

Diagonal Plaid
8" row

© Patricia E. Ritter

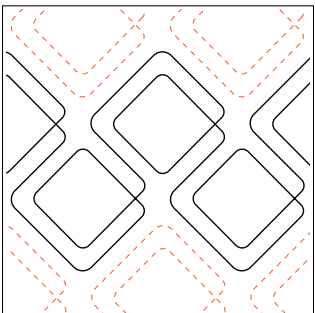

Diagonal Plaid - Bias Cut
6.25" row

© Patricia E. Ritter

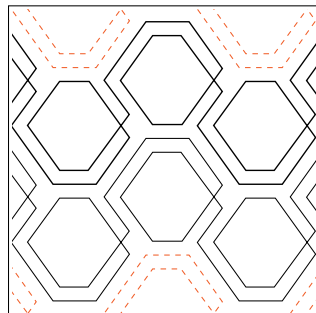

Diagonal Plaid - Hexies
6.5" row

© Patricia E. Ritter & Leisha Farnsworth

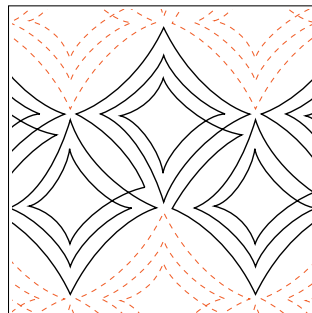

Diamonds are Forever
9.25" row

© Patricia E. Ritter

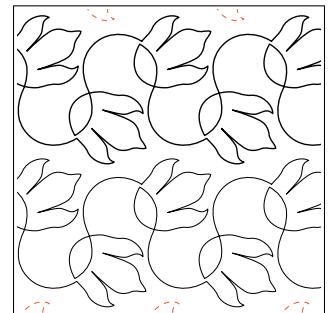

Dino Prints
5.75" row

© Timeless Quilting Designs

Edge-to-Edge, Corner & Block Designs

Pre-printed quilting paper compatible with any domestic or longarm quilting machine and frame.



Dolce
5" row

© Patricia E. Ritter & Jamie Wallen / Quilters Apothecary

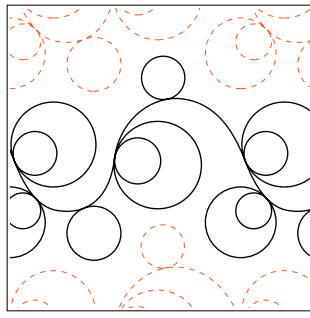

Double Bubble #1 - Petite
6" row

© Patricia E. Ritter

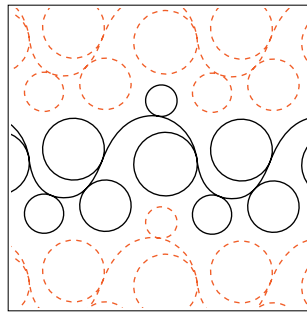

Double Bubble #2 - Petite
6" row

© Patricia E. Ritter

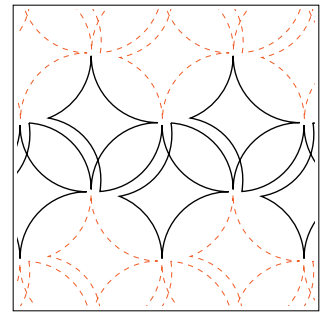

Easy Orange Peel
6.5" row

© Patricia E. Ritter

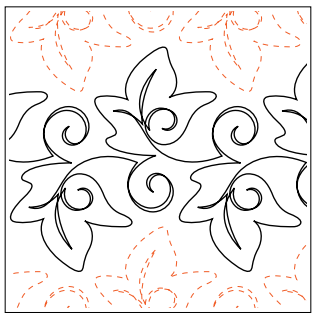

English Ivy - Border
5.75" row

© Patricia E. Ritter

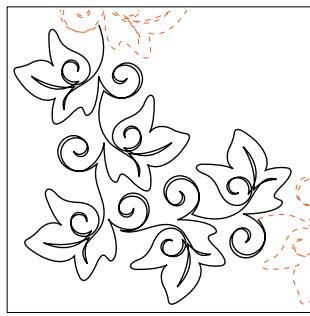

English Ivy - Border - Corner

© Patricia E. Ritter



English Ivy - Block #6
11.5" block

© Patricia E. Ritter

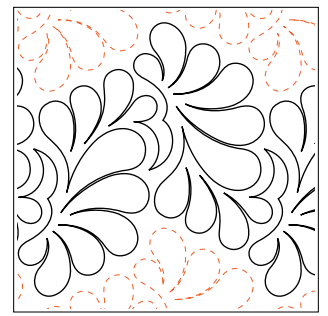

Escarole
8.5" row

© Patricia E. Ritter

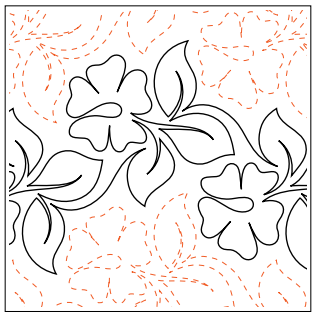

Evening Primrose - Petite
6.75" row

© Patricia E. Ritter & Kyla Trammell

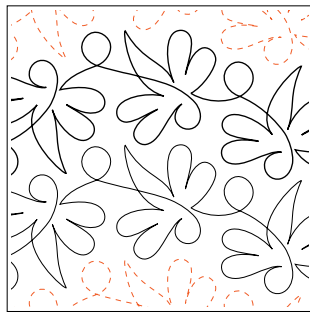

EZ Dragonflies
6" row

© Patricia E. Ritter

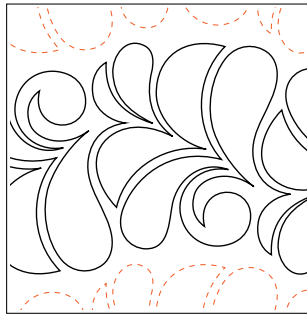

Fable
7.25" row

© OESD & Jeffery Schillinger

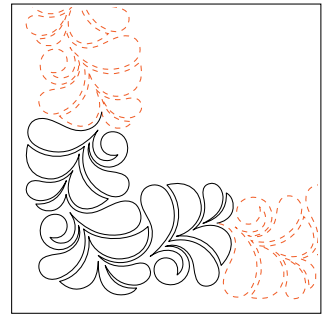

Fable - Corner

© OESD & Jeffery Schillinger

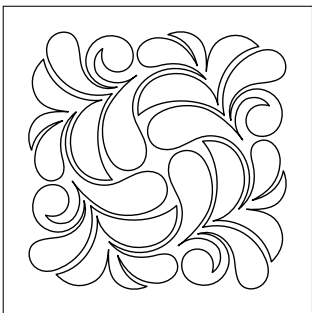

Fable - Block
11.5" block

© OESD & Jeffery Schillinger

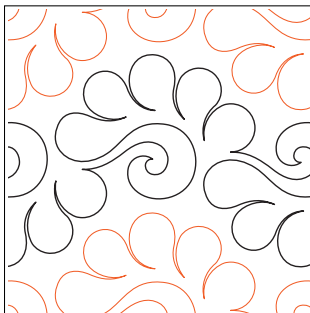

Feather Flip
6.75" row

© Hermione Agee

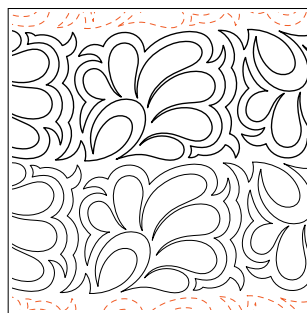

Feather Flower - Border
3.75" row

© Darlene Epp

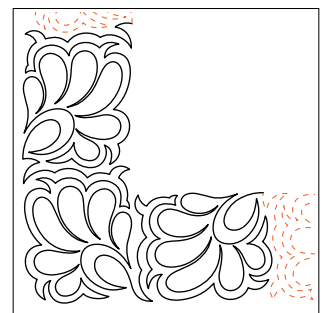

Feather Flower - Border - Corner

© Darlene Epp

Edge-to-Edge, Corner & Block Designs

Pre-printed quilting paper compatible with any domestic or longarm quilting machine and frame.

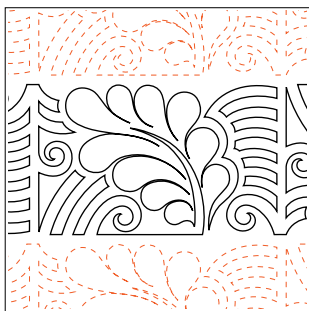

Feathered Mola - Petite
5.5" row

© Patricia E. Ritter

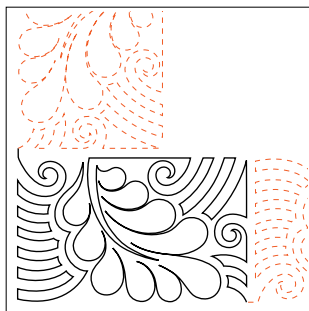

Feathered Mola - Petite - Corner

© Patricia E. Ritter

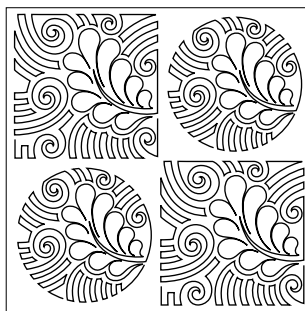

Feathered Mola - Block Set
9.5" blocks

© Patricia E. Ritter



Feliz Navidad - Stocking
12.5" x 18" stocking

© Patricia E. Ritter & OESD

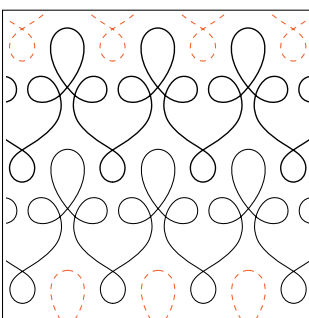

Filigree
5.75" row

© Patricia E. Ritter

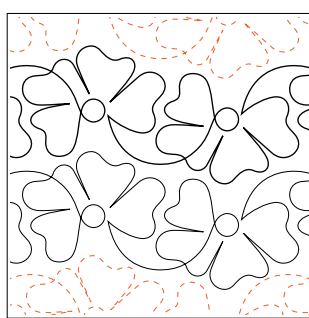

First Kiss
5.25" row

© Patricia E. Ritter & Denise Schillinger

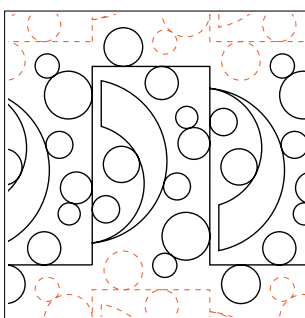

Fizzle
10.5" row

© Melonie J. Caldwell



Fleur De Lis Shield - Border
4.75" row

© Deb Geissler

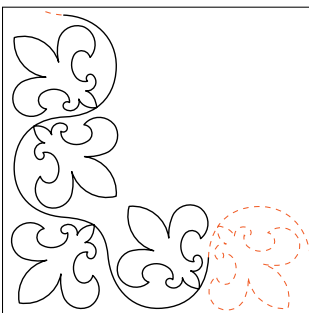

Fleur De Lis Shield - Border - Corner

© Deb Geissler

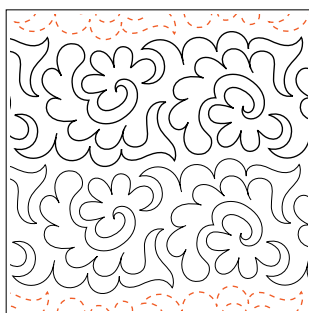

Flowers and Fronds
5" row

© Patricia E. Ritter

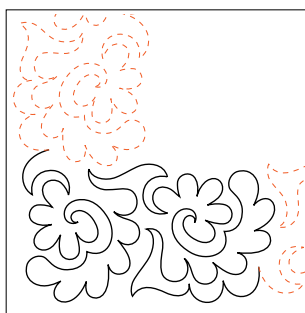

Flowers and Fronds - Corner

© Patricia E. Ritter

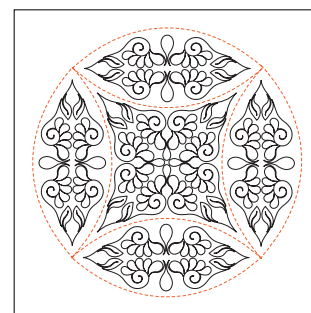

Flowers In My Wedding Ring - DWR - Block
fits 18" circle

© Naomi Hynes

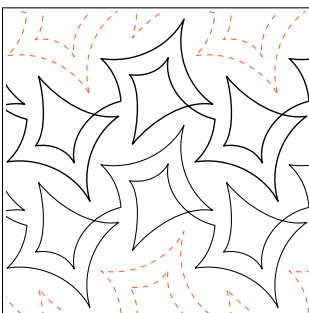

Fragments
5.75" row

© Melonie J. Caldwell

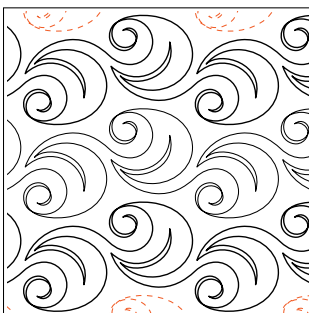

Fresh Air
4" row

© Patricia E. Ritter & Jamie Wallen / Quilters Apothecary

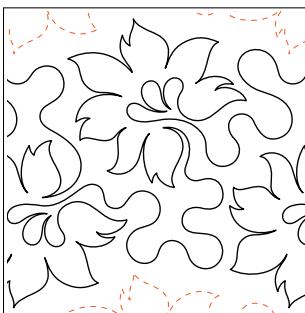

Garden Flower
9.75" row

© Dave Hudson

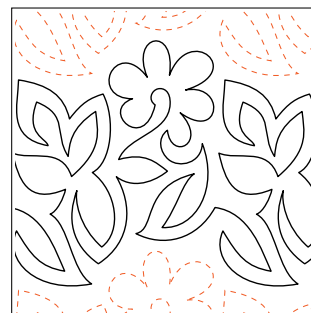

Garden Walk
7.5" row

© Barbara Becker

Edge-to-Edge, Corner & Block Designs

Pre-printed quilting paper compatible with any domestic or longarm quilting machine and frame.

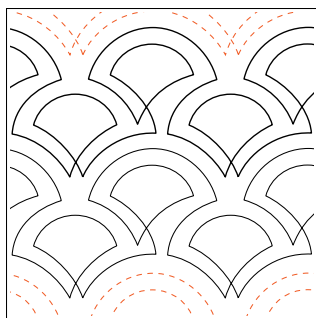

Geisha
5.5" row

© Melonie J. Caldwell

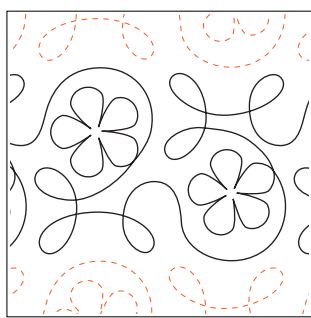

Ginger Flower
6.5" row

© Apricot Moon Designs

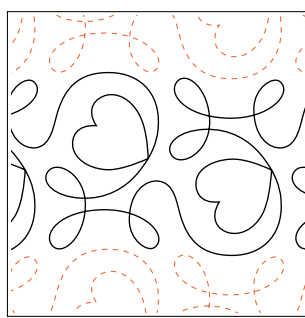

Ginger Heart
6.5" row

© Apricot Moon Designs

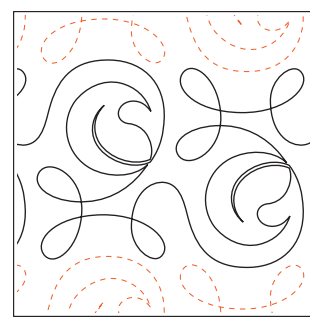

Ginger Leaf
6.5" row

© Apricot Moon Designs

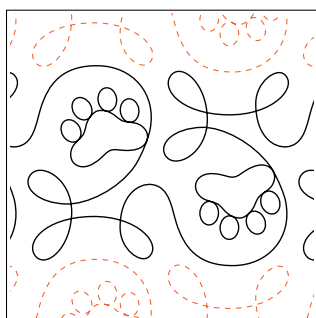

Ginger Paw
6.25" row

© Melonie J. Caldwell & Apricot Moon Designs

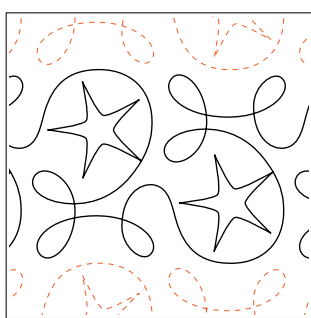

Ginger Star
6.5" row

© Apricot Moon Designs

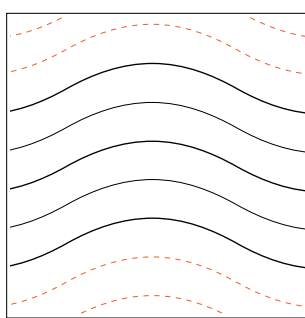

Good Vibrations #1
1.75" row

© Patricia E. Ritter

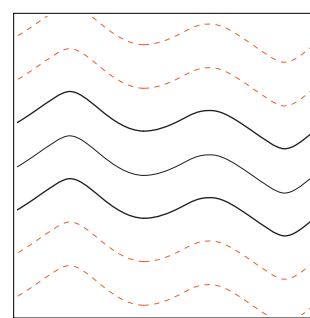

Good Vibrations #2
2" row

© Patricia E. Ritter

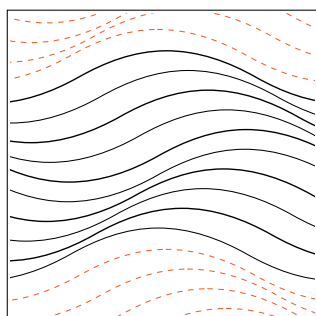

Good Vibrations - Offset
2" row

© Patricia E. Ritter

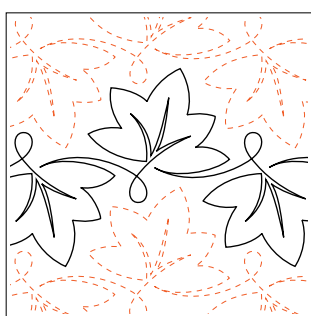

Grapevine
6.5" row

© Denise Schillinger

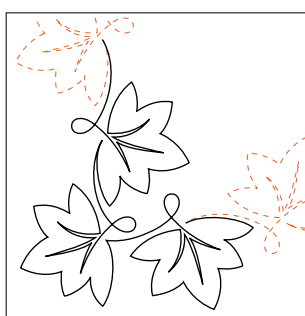

Grapevine - Corner

© Denise Schillinger

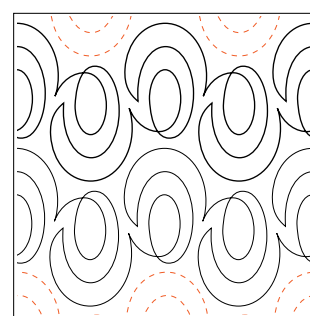

Gravity
5" row

© Melonie J. Caldwell

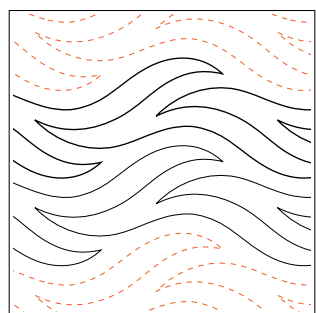

Gulf Stream
3.75" row

© Patricia E. Ritter & Lynne A. Cohen

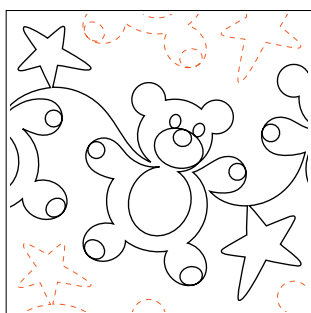

Gummy Bears
7.25" row

© Patricia E. Ritter

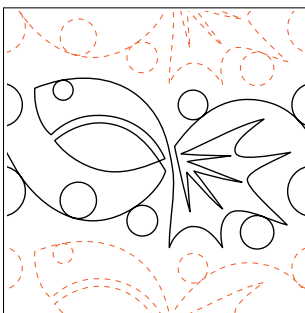

Guppy
5.25" row

© Patricia E. Ritter & Jeffery Schillinger

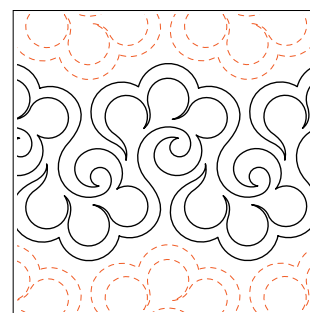

Halcyon
7.5" row

© Hermione Agee

Edge-to-Edge, Corner & Block Designs

Pre-printed quilting paper compatible with any domestic or longarm quilting machine and frame.

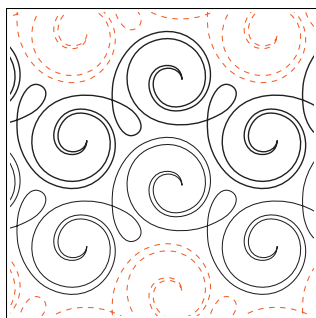

Happy
5" row

© Patricia E. Ritter & Denise Schillinger

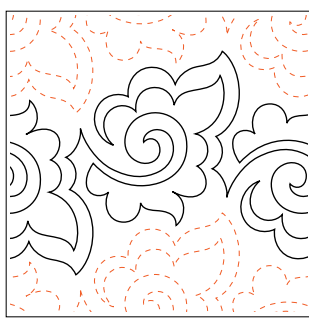

Harmony
6" row

© Patricia E. Ritter & Valerie Smith

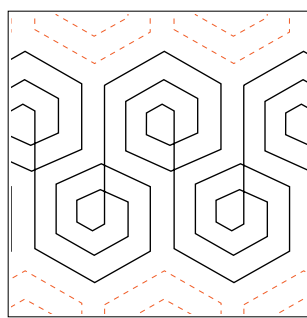

Hex Marks the Spot
7" row

© Patricia E. Ritter

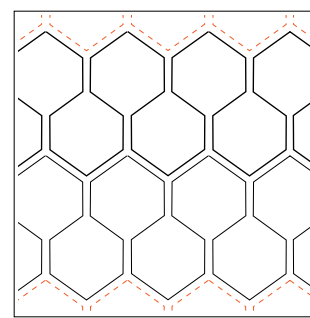

Hexies
5.25" row

© Patricia E. Ritter

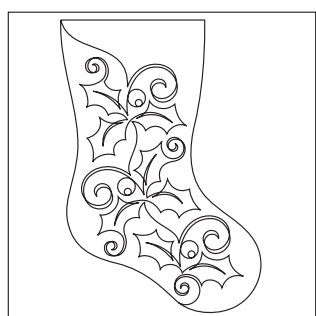

Holiday Garland - Stocking
12.5" x 18" stocking

© Patricia E. Ritter

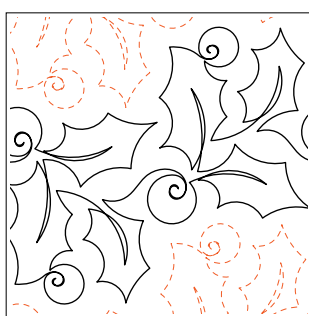

Holly Berries
7.25" row

© Hermione Agee

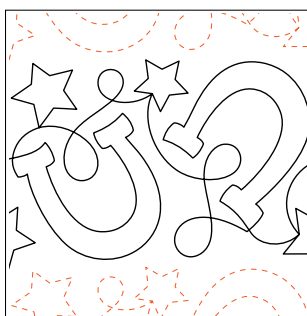

Horseshoes
7" row

© Jessica Schick

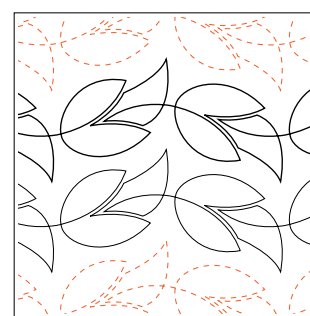

Ittybitty Buds
5" row

© Jessica Schick

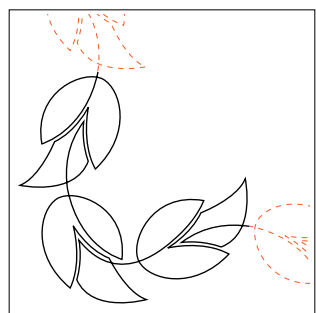

Ittybitty Buds - Corner

© Jessica Schick

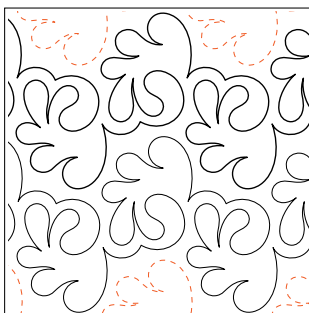

Japanese Waves
8" row

© Hermione Agee

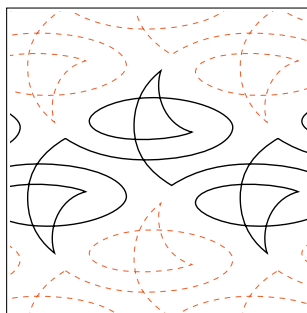

Jester
6.5" row

© Melonie J. Caldwell

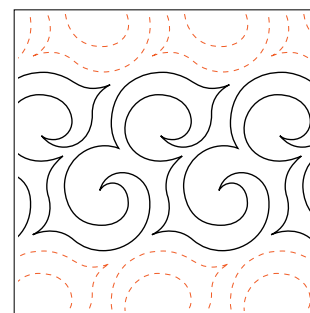

Jilly
6" row

© Keryn Emmerson

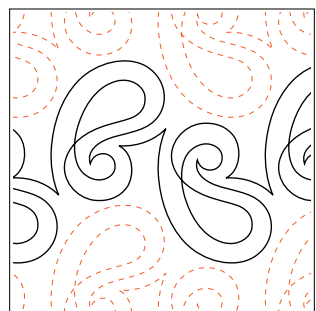

Jive
6.5" row

© Melonie J. Caldwell

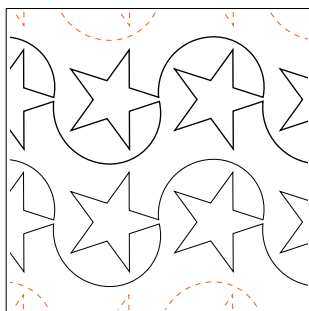

Julie's Star
4" row

© Julie Mullin

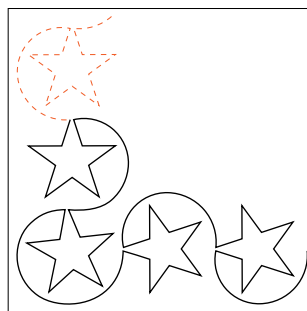

Julie's Star - Corner

© Julie Mullin

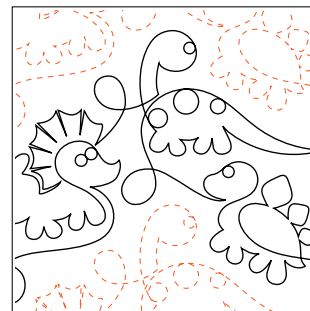

Jurassic Babies
10.75" row

© Patricia E. Ritter

Edge-to-Edge, Corner & Block Designs

Pre-printed quilting paper compatible with any domestic or longarm quilting machine and frame.

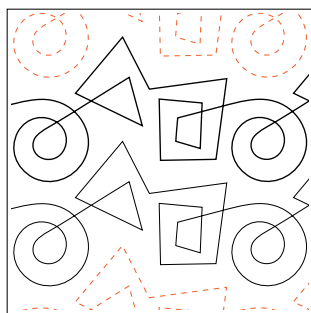

Kandinsky - Petite
4.5" row

© Patricia E. Ritter

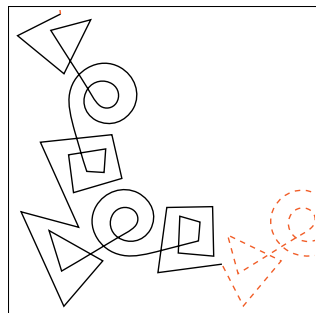

Kandinsky - Petite - Corner

© Patricia E. Ritter

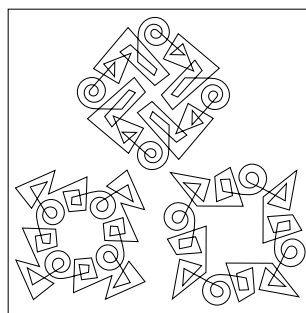

Kandinsky - Block Set
11.5" blocks

© Patricia E. Ritter

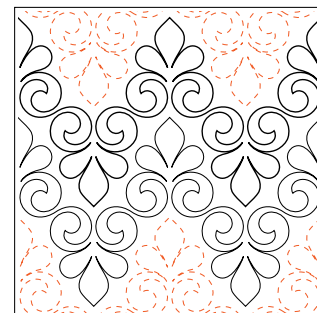

Kaylee's Fleur De Lys
8.75" row

© Patricia E. Ritter & Helen Squire

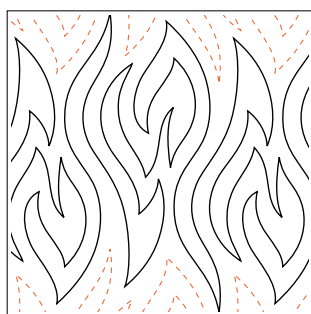

Kindling
7.75" row

© Patricia E. Ritter & Leisha Farnsworth

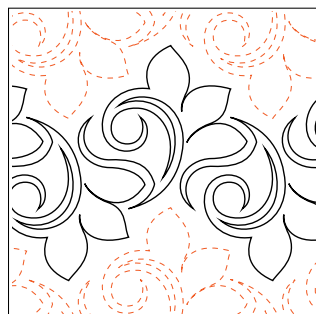

Kismet
6.75" row

© Patricia E. Ritter & Denise Schillinger

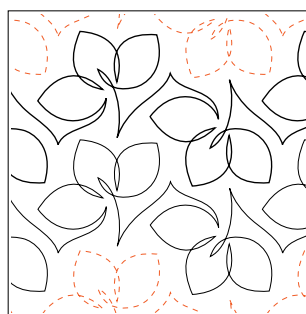

La Fleur
5.5" row

© Sarah Ann Myers

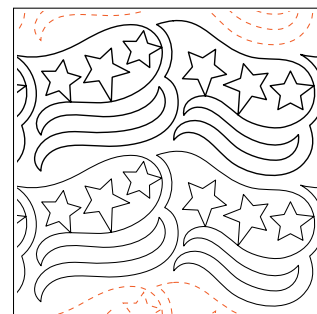

Lakeridge's Patriotic
5.5" row

© Lakeridge Designs / Kimberly Dewling

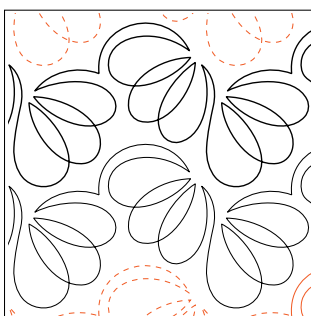

Lemon Peel
6" row

© Lakeridge Designs / Kimberly Dewling

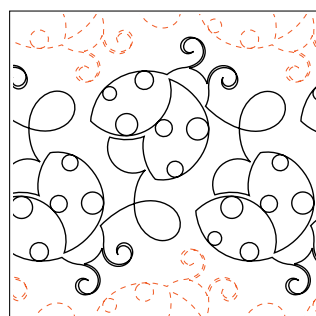

Lil Ladybugs
8.5" row

© Patricia E. Ritter

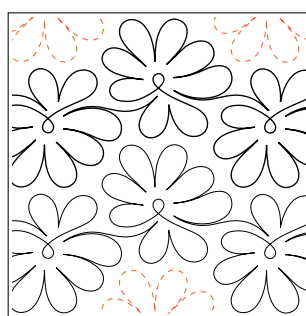

Lilac
5.75" row

© Sarah Ann Myers

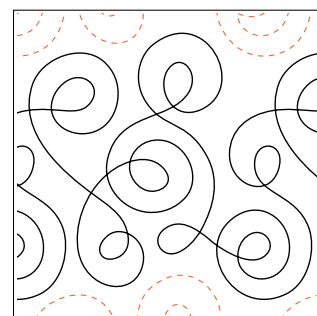

Loop the Loop
7.75" row

© Barbara Becker / Four Paws Quilting

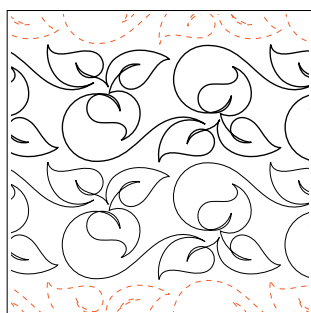

Loose Leaf
4.25" row

© Patricia E. Ritter

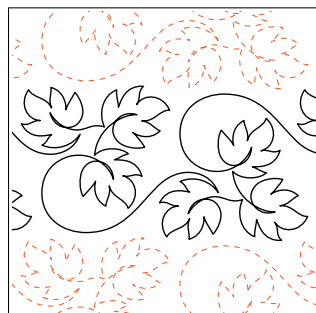

Loose Leaf - Fall
5" row

© Patricia E. Ritter

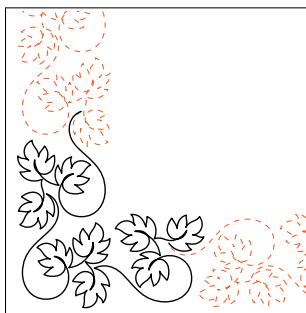

Loose Leaf - Fall - Corner

© Patricia E. Ritter

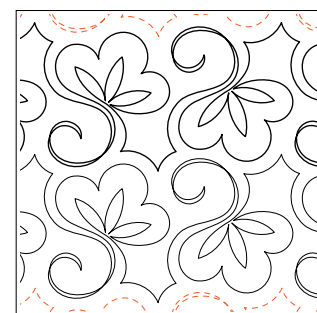

Lorien's Sweet Pea
4.5" row

© Hermione Agee

Edge-to-Edge, Corner & Block Designs

Pre-printed quilting paper compatible with any domestic or longarm quilting machine and frame.

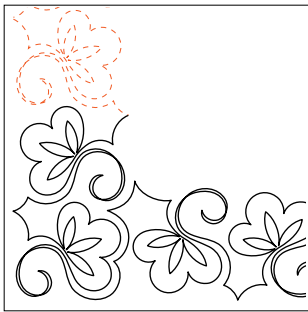

Lorien's Sweet Pea - Corner

© Hermione Agee

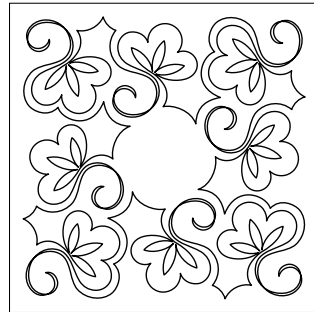

Lorien's Sweet Pea - Block
11.5" block

© Hermione Agee

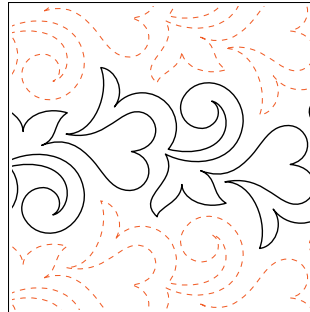

Love Song
6.75" row

© Patricia E. Ritter

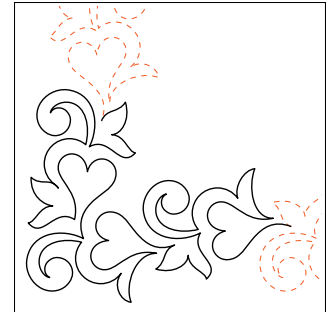

Love Song - Corner

© Patricia E. Ritter

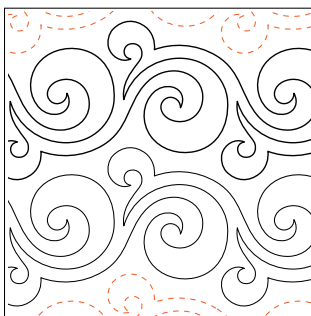

Lovely - Petite
5.75" row

© Patricia E. Ritter & Denise Schillinger

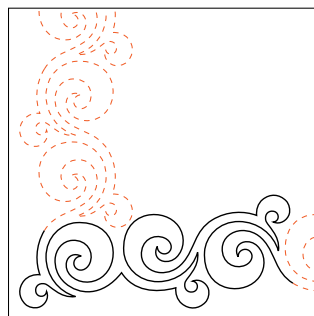

Lovely - Petite - Corner

© Patricia E. Ritter & Denise Schillinger

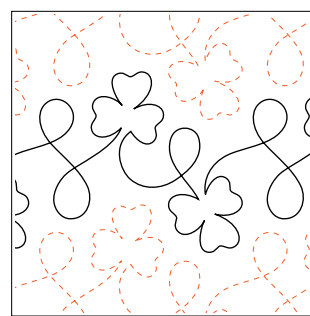

Luck of the Irish
6.5" row

© Nancy Read

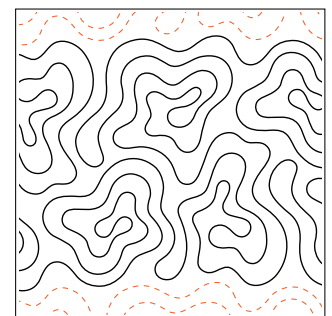

Malachite
9" row

© Patricia E. Ritter

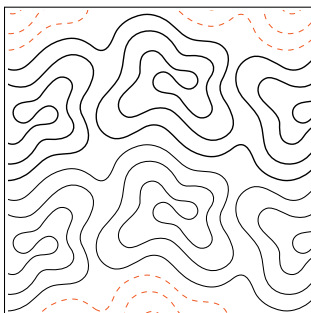

Malachite - Petite
6" row

© Patricia E. Ritter

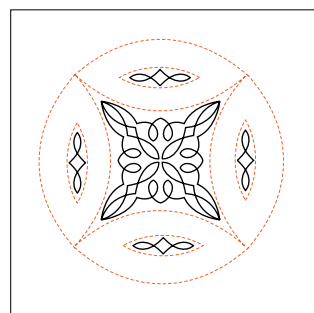

Mary Kathryn Lace - DWR - Block
fits 15" circle

© Jessica Schick

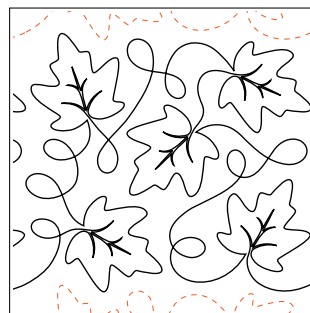

Maureen's Maple Leaves
8.25" row

© Maureen Foster / Humble Bee Quilting

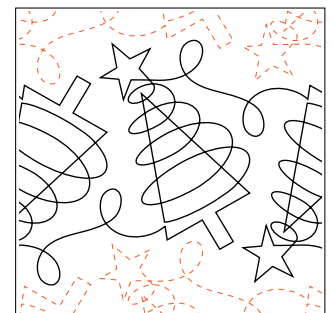

Merry and Bright
8.5" row

© Melonie J. Caldwell

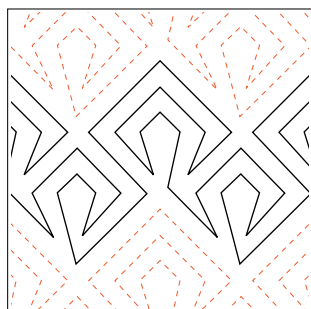

Miami Beach
7" row

© Melonie J. Caldwell

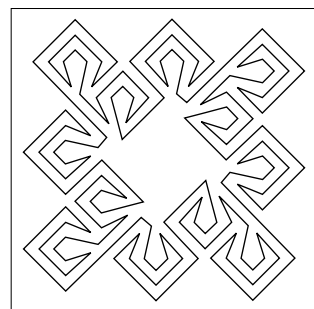

Miami Beach - Block
15.5" block

© Melonie J. Caldwell

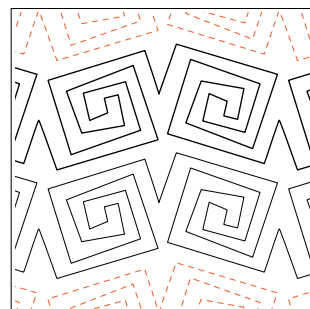

Midway
5" row

© Patricia E. Ritter & Tracey Russell

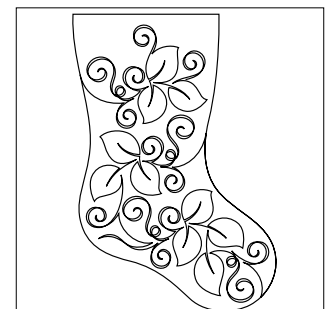

Mint Julep - Stocking
12.5" x 18" stocking

© Patricia E. Ritter

Edge-to-Edge, Corner & Block Designs

Pre-printed quilting paper compatible with any domestic or longarm quilting machine and frame.

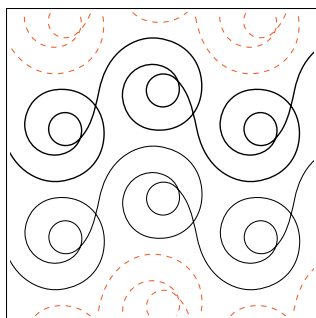

Mod Dot
4.25" row
© Patricia E. Ritter

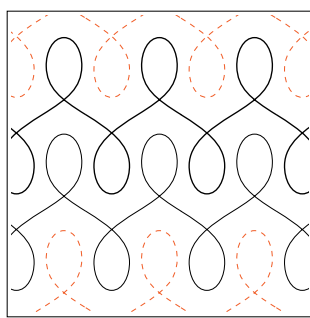

Modern Twist
6" row
© Patricia E. Ritter



Moulin Rouge - Stocking
12.5" x 18" stocking
© Patricia E. Ritter



Mushroom Patch
5.5" row
© Beany Girl Quilts

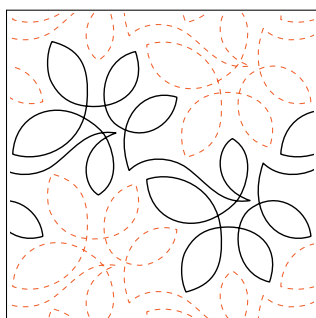

Netting #1
8.75" row
© Sarah Ann Myers

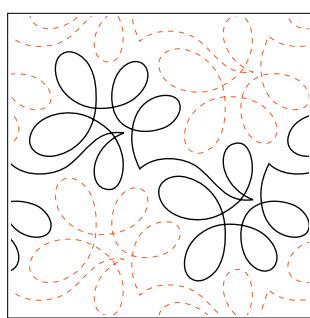

Netting #2
8.25" row
© Sarah Ann Myers

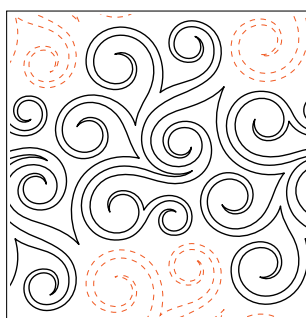

Nocturne
11" row
© OESD & Jeffery Schillinger

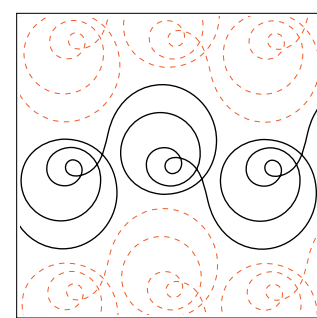

Orbit
5.5" row
© Sarah Ann Myers

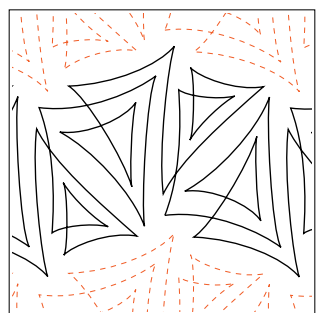

Papyrus
7.75" row
© Patricia E. Ritter & OESD

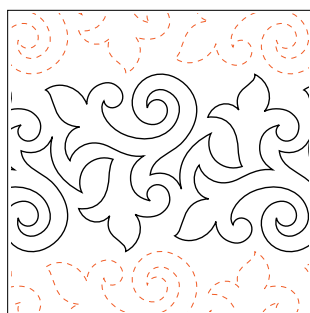

Pashmina - Petite
5" row
© Patricia E. Ritter

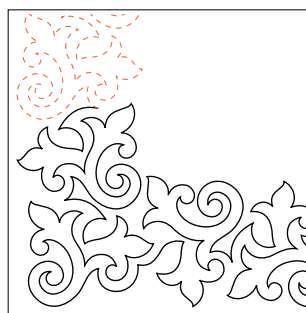

Pashmina - Petite - Corner
© Patricia E. Ritter

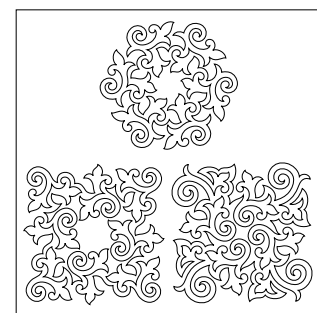

Pashmina - Petite - Block Set
11.5" blocks
© Patricia E. Ritter



Pergola - Petite
6.5" row
© Patricia E. Ritter & Tracey Russell



Pergola - Petite - Corner
© Patricia E. Ritter & Tracey Russell

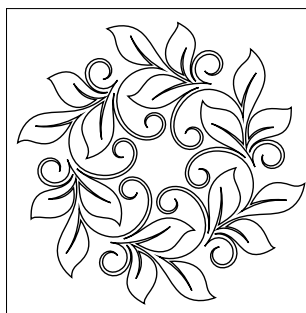

Pergola - Block #3
13" block
© Patricia E. Ritter & Tracey Russell

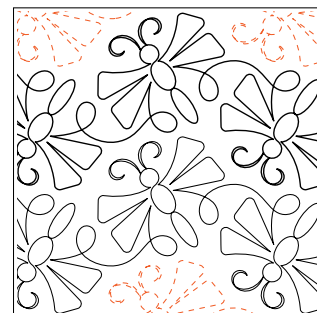

Petal Tails
8" row
© Patricia E. Ritter & Jeffery Schillinger

Edge-to-Edge, Corner & Block Designs

Pre-printed quilting paper compatible with any domestic or longarm quilting machine and frame.

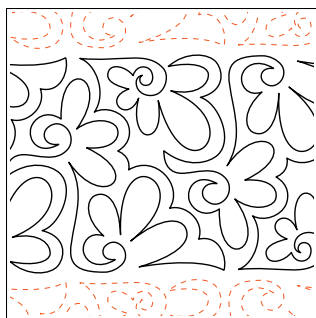

Petals Forever
6.75" row

© Melissa Kelley

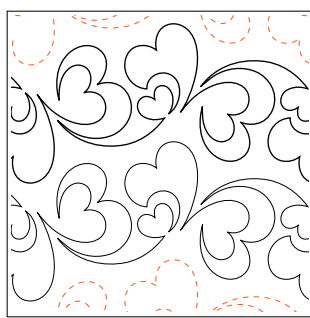

Pieces of My Heart
5.25" row

© Melonie J. Caldwell

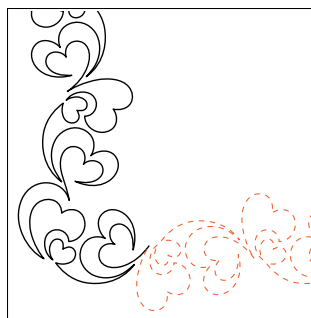

Pieces of My Heart - Corner

© Melonie J. Caldwell

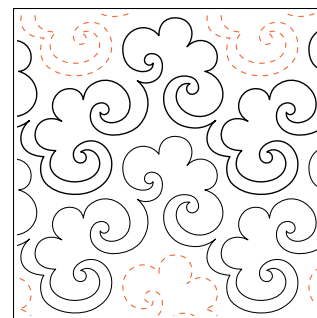

Popcorn
7" row

© Willow Leaf Designs

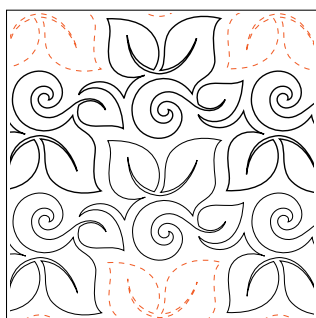

Poplar
8.25" row

© Patricia E. Ritter

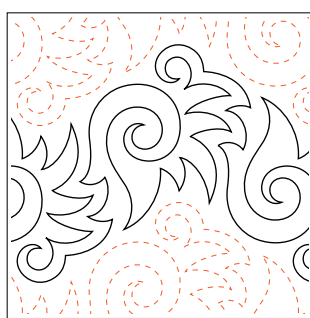

Presto
6.75" row

© Patricia E. Ritter

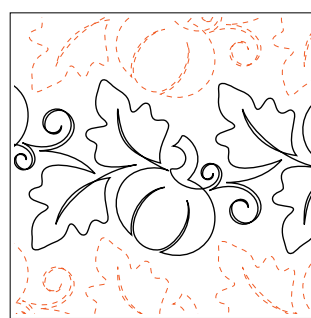

Pumpkin Fest - Petite
5.5" row

© Patricia E. Ritter & Melonie J. Caldwell



Pumpkin Fest - Petite - Corner

© Patricia E. Ritter & Melonie J. Caldwell

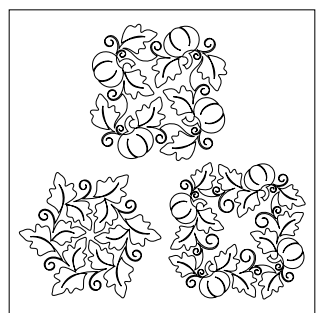

Pumpkin Fest - Petite - Block Set
11.5" blocks

© Patricia E. Ritter & Melonie J. Caldwell

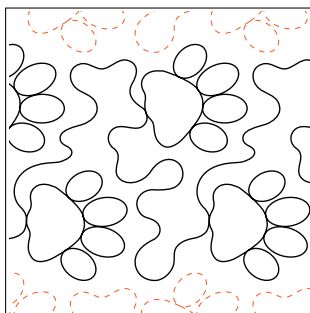

Puppy Paws
8.75" row

© Jessica Schick

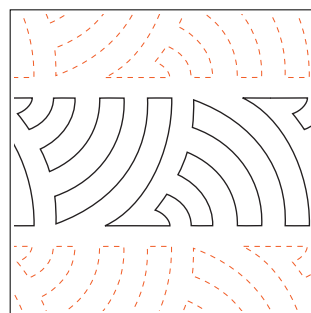

Quarter Clams
4.5" row

© Patricia E. Ritter

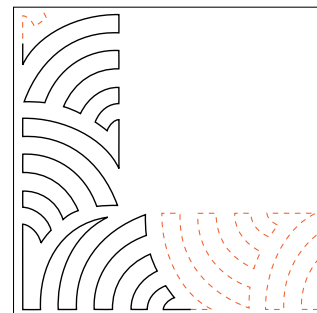

Quarter Clams - Corner

© Patricia E. Ritter

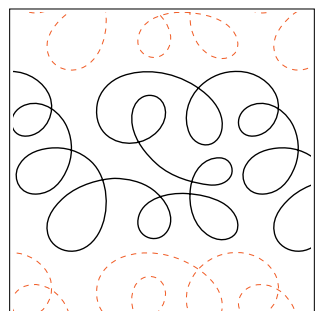

Ragtime
7.25" row

© Patricia E. Ritter

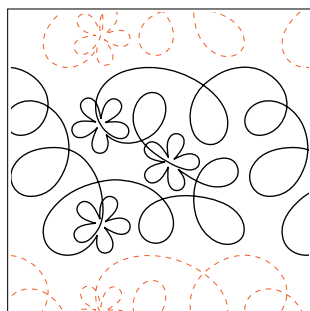

Ragtime - Flowers
7.25" row

© Patricia E. Ritter

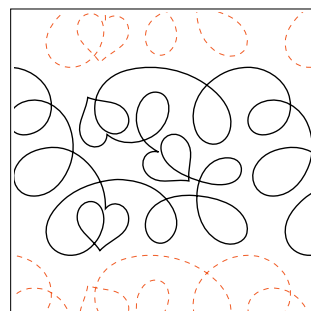

Ragtime - Hearts
7.25" row

© Patricia E. Ritter

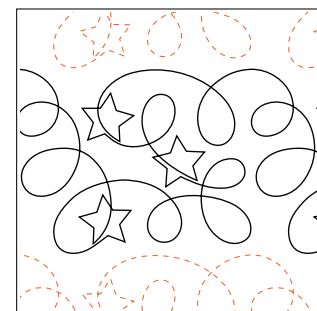

Ragtime - Stars
7.25" row

© Patricia E. Ritter

Edge-to-Edge, Corner & Block Designs

Pre-printed quilting paper compatible with any domestic or longarm quilting machine and frame.

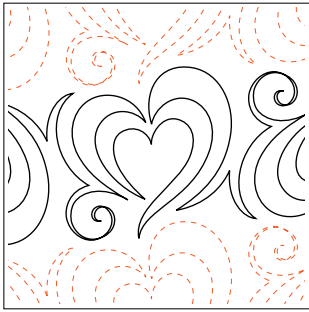

Red Hot
4.75" row

© Patricia E. Ritter & Melonie J. Caldwell

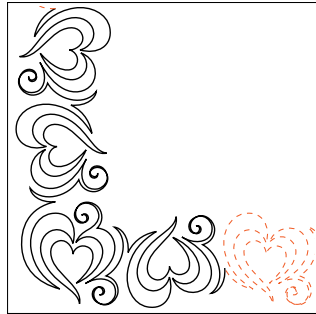

Red Hot - Corner

© Patricia E. Ritter & Melonie J. Caldwell

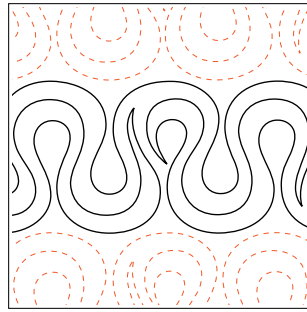

Ribbon Candy
5.25" row

© Patricia E. Ritter

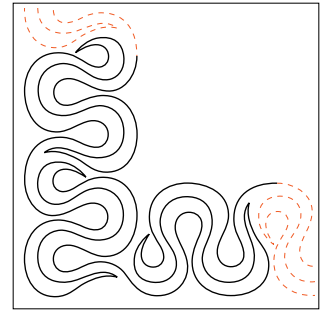

Ribbon Candy - Corner

© Patricia E. Ritter

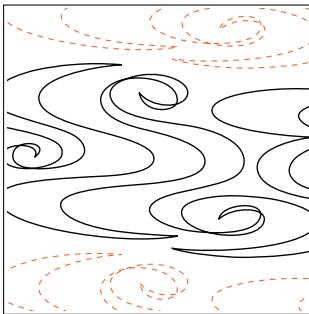

Ripples
8.5" row

© Hermione Agee

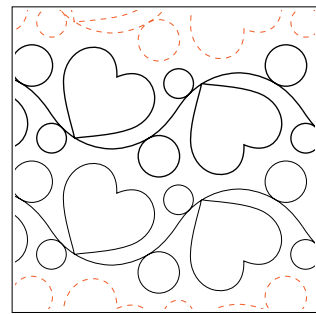

Rock 'n Roll Heartz - Petite
5" row

© Patricia E. Ritter

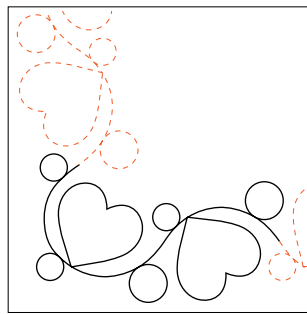

Rock 'n Roll Heartz - Petite - Corner

© Patricia E. Ritter

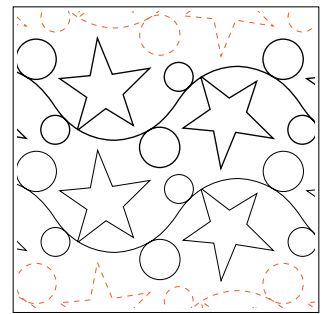

Rock 'n Roll Starz - Petite
5" row

© Patricia E. Ritter

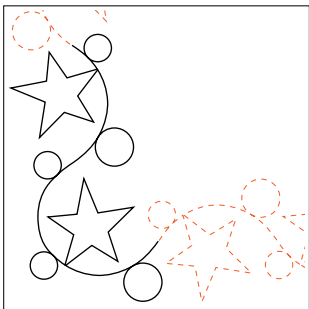

Rock 'n Roll Starz - Petite - Corner

© Patricia E. Ritter

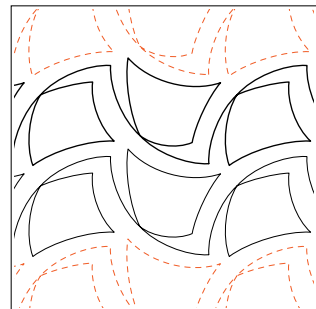

Scrap Paper
3.75" row

© Keryn Emmerson

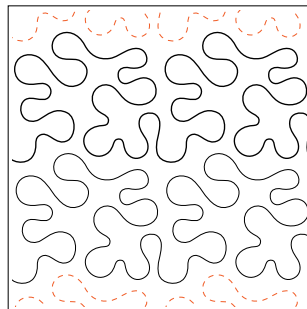

Scribbles - Petite
4.5" row

© Patricia E. Ritter

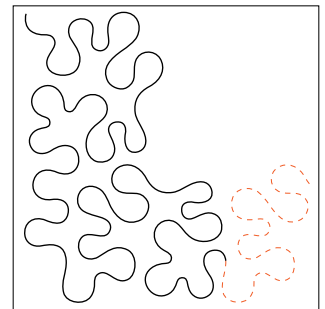

Scribbles - Petite - Corner

© Patricia E. Ritter

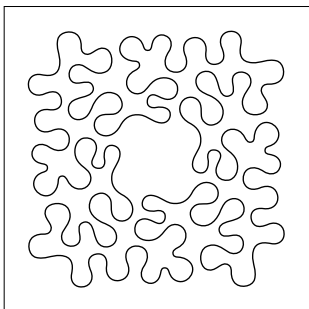

Scribbles - Block
11.5" block

© Patricia E. Ritter

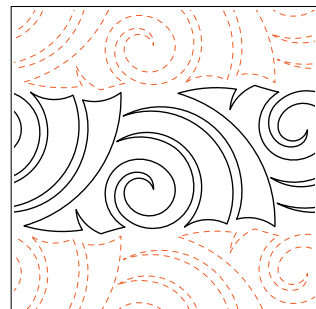

Shale
5" row

© Keryn Emmerson



Shale - Corner

© Keryn Emmerson

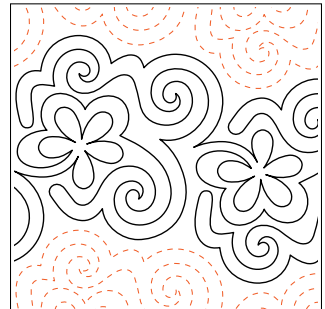

Shalimar
8.75" row

© Patricia E. Ritter

Edge-to-Edge, Corner & Block Designs

Pre-printed quilting paper compatible with any domestic or longarm quilting machine and frame.

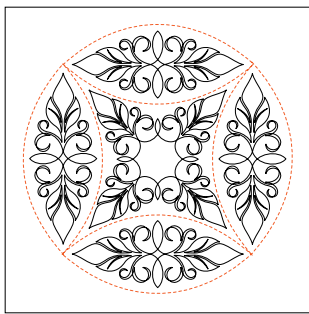

Shire - DWR - Block
fits 18" circle

© Jessica Schick

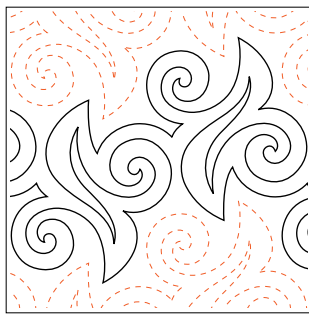

Silver
7" row

© Patricia E. Ritter

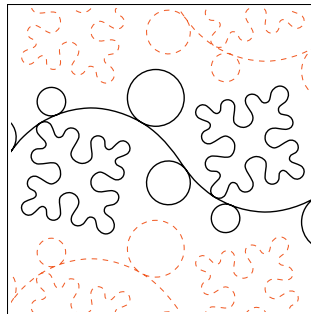

Snowdrift
6" row

© Patricia E. Ritter

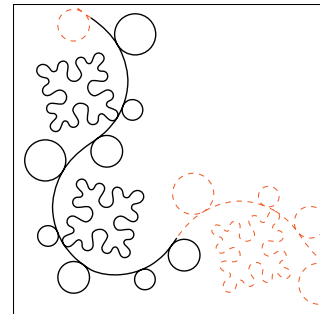

Snowdrift - Corner

© Patricia E. Ritter

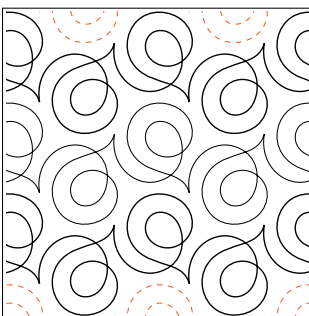

Soho
4.5" row

© Sarah Ann Myers

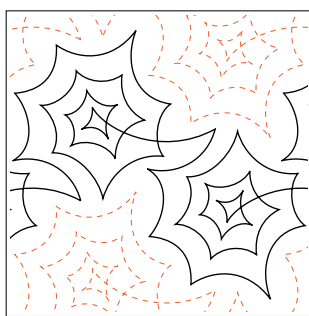

Spindle
10.25" row

© Patricia E. Ritter & Melonie J. Caldwell

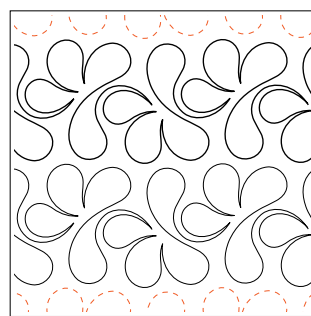

Splish Splash
4.25" row

© Sarah Ann Myers

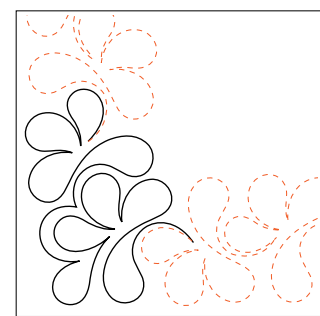

Splish Splash - Corner

© Sarah Ann Myers

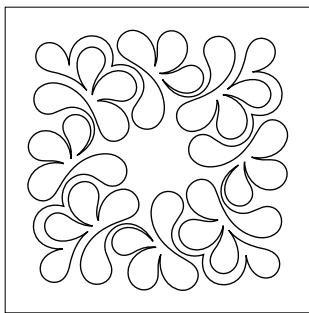

Splish Splash - Block
9.75" block

© Sarah Ann Myers

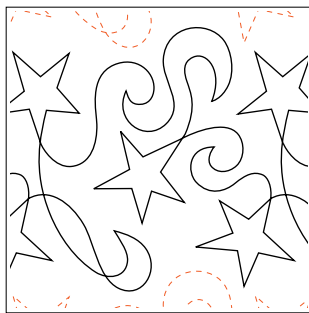

Star Dance
6.75" row

© Barbara Becker



Starry Night - Stocking
12.5" x 18" stocking

© Patricia E. Ritter & Melonie J. Caldwell

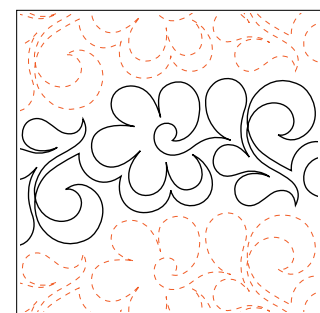

Sun Kissed - Petite
4.75" row

© Patricia E. Ritter

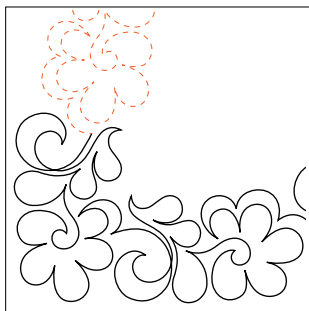

Sun Kissed - Petite - Corner

© Patricia E. Ritter

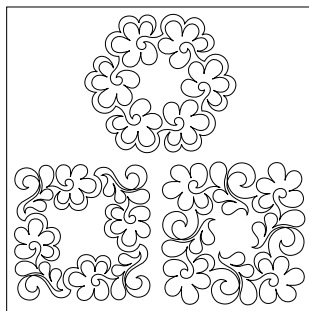

Sun Kissed - Petite - Block Set
11.25" blocks

© Patricia E. Ritter

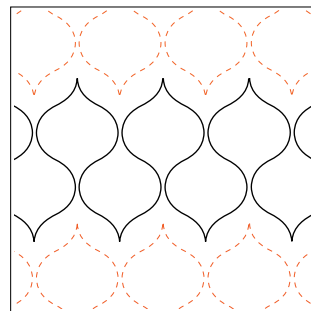

Taj Mahal
5.5" row

© Patricia E. Ritter & Leisha Farnsworth

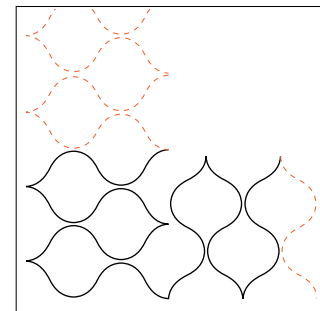

Taj Mahal - Corner

© Patricia E. Ritter & Leisha Farnsworth

Edge-to-Edge, Corner & Block Designs

Pre-printed quilting paper compatible with any domestic or longarm quilting machine and frame.

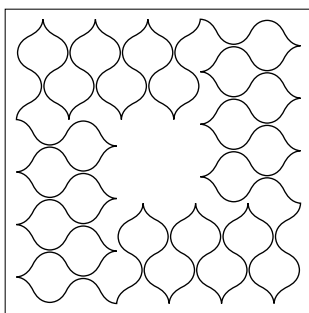

Taj Mahal - Block
15.5" block

© Patricia E. Ritter & Leisha Farnsworth

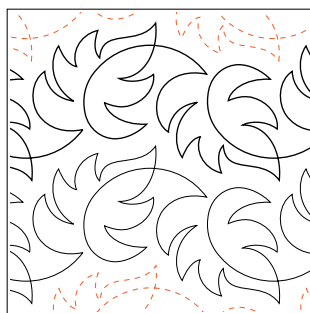

Terrace
4.25" row

© Sarah Ann Myers

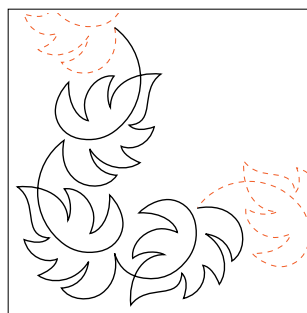

Terrace - Corner

© Sarah Ann Myers

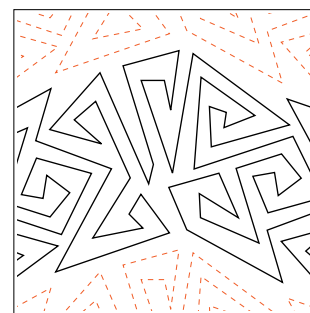

Tilt - O - Whirl
9.75" row

© Patricia E. Ritter & Marybeth O'Halloran

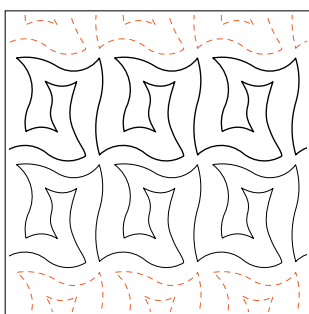

Topsy Spiral
3.75" row

© Keryn Emmerson

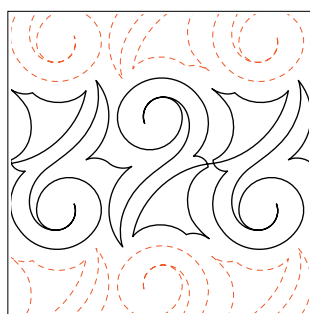

Tisket
5" row

© Keryn Emmerson

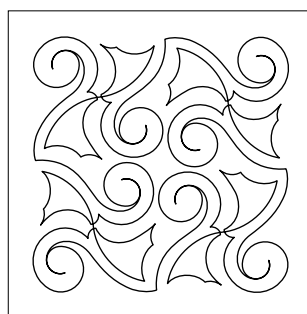

Tisket - Block
11.5" block

© Keryn Emmerson

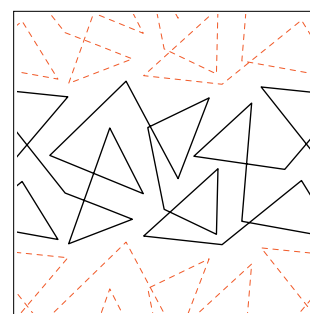

Triangle Meander - Border
5.25" row

© Deb Geissler

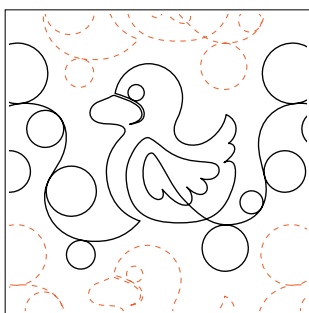

Tubby Duckies
8.5" row

© Patricia E. Ritter & Lynne A. Cohen

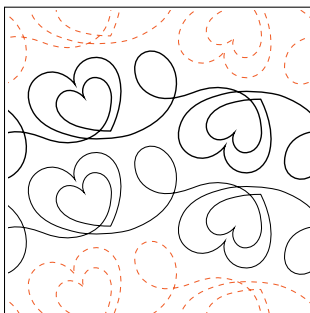

Two of Hearts
4" row

© Melonie J. Caldwell

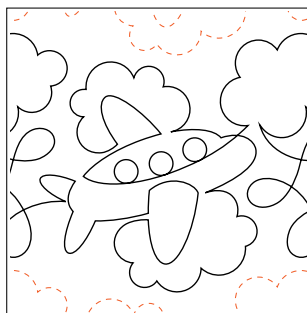

Up Up and Away
7.75" row

© Sarah Ann Myers

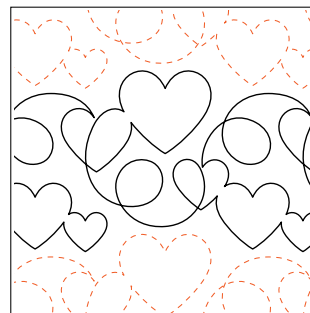

Waltzing Hearts
5.5" row

© Mel St. Clair

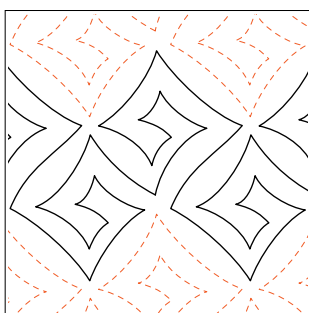

Wasabi
7.25" row

© Patricia E. Ritter

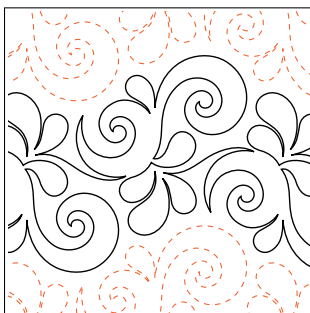

Wave on Wave
8.5" row

© Patricia E. Ritter

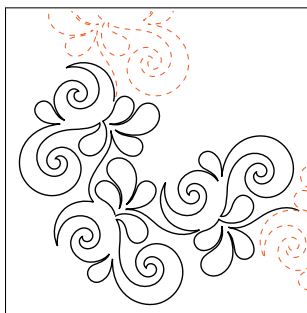

Wave on Wave - Corner

© Patricia E. Ritter

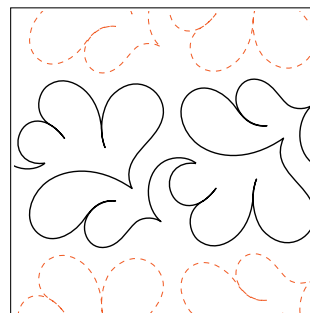

Whirlwind - Petite
4.5" row

© Patricia E. Ritter

Edge-to-Edge, Corner & Block Designs

Pre-printed quilting paper compatible with any domestic or longarm quilting machine and frame.

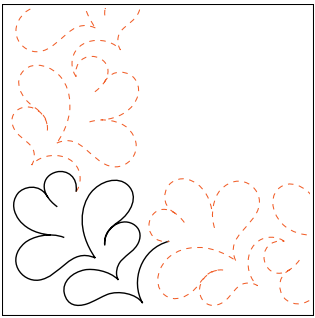

Whirlwind - Petite - Corner

© Patricia E. Ritter

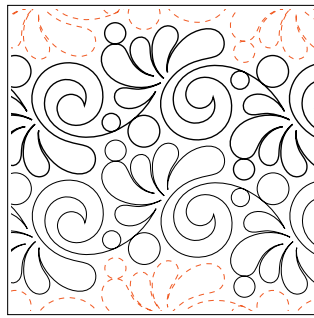

Whisper
6.25" row

© Melonie J. Caldwell

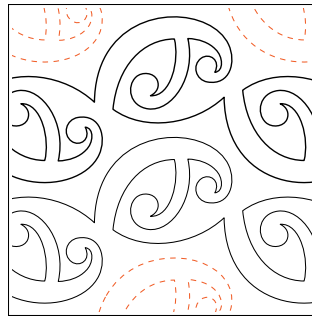

Willow Leaf's Fiddlehead
6.5" row

© Willow Leaf Designs

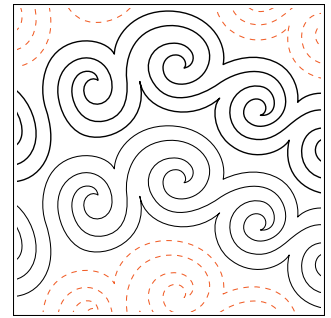

Willow Leaf's Hypnotic
7.5" row

© Willow Leaf Designs

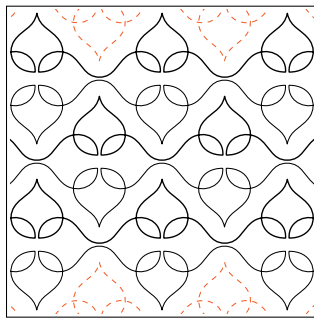

Willow Leaf's Starlight
2.75" row

© Willow Leaf Designs

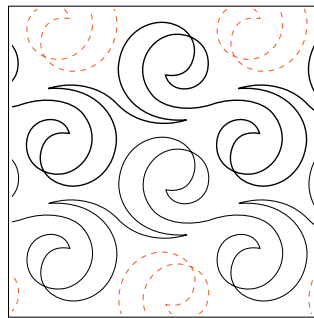

Windswept
6.25" row

© Naomi Hynes

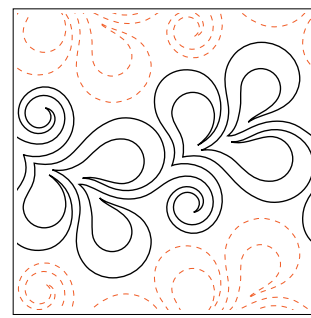

Xanadu
6.25" row

© Patricia E. Ritter

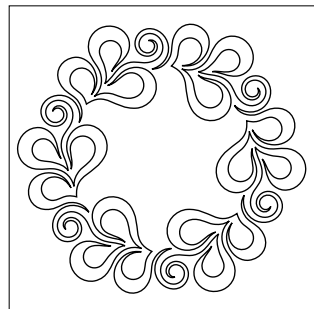

Xanadu - Block
13.5" block

© Patricia E. Ritter

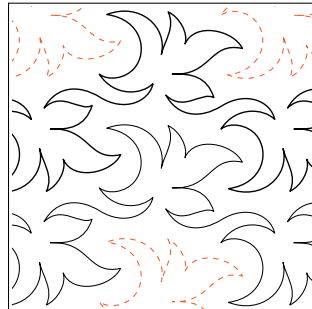

Zest
7.5" row

© Patricia E. Ritter

Notes:

© All rights reserved.
Copyright and designer info available upon request.



Visit our website at:

www.urbanelementz.com
www.appliqueelementz.com

To see our entire selection of:

Pantographs
Tear Away
Stencils
Design Boards
Appliqué Elementz
Tattoo Elementz - Decorative Decals
Patterns and Books
Quilting Accessories



1308 common street
suite 205 . box 50
new braunfels . texas . 78130
830 . 964 . 6133